

BOSSWELD

FIRESTORM **ELECTRONIC** **WELDING HELMET**



INSTRUCTION MANUAL

Thank you for choosing a **BOSSWELD Electronic Welding Helmet**. In this manual you will find instructions on how to set up your welding helmet along with general welding information safety information and helpful tips. We encourage you to go online to our website for more tips and troubleshooting as well as many welding resources.

IMPORTANT: REMOVE PROTECTIVE FILMS BEFORE USE!

Before using the welding helmet, user must remove the protective films from both the inner and outer lenses. These films are only there to prevent scratches during manufacturing and shipping. If you don't remove them, your vision will be blurry and obscured. (Page 7 Step 1)

BOX CONTENTS

1. Auto Darkening Welding Helmet
2. Spare Outer Lens x 1
(137 x 118mm)
3. Spare Inner Lens x 1
(104 x 97mm)



SPECIFICATIONS

Part No.	710400
Viewing Area	100 x 93mm (93cm ²)
Grind Function	Yes - External & Internal Switch
Optical Class	1 / 1 / 1 / 1
TrueView+ Technology	YES
UV/IR Protection	Permanent, DIN16
Operating Display	LCD
Arc Sensors	4+1 (Ambient Light)
Switching Time	0.04ms
A/M Function	YES
Manual-Shade State	W3 / 4-8 / 9-13, 0.5INC
Auto-Shade Control	3/7<13, 0.1INC
Auto-Shade Deviation	-2~+2
Shade Lock (PASSIVE mode)	YES
Sensitivity Variable	Internal (Digital LCD Display)
Delay Time Variable	0.05-2.0s, Internal
COMFORT+SPOT function	YES
Memory	9, User Programmable
SELF-TEST	YES
On/Off Function	YES
Power Supply	Solar Cell & Replaceable Li-Battery CR2032 X 2
TIG Rating	>2A
Operation Temp.	-10°C – +60°C
Warranty	2 years

SPARES PART

PART NO.	DESCRIPTION
710418	Bossweld Firestorm Electronic Lens
710417	Bossweld Firestorm Helmet Lens Pack (5 outer lens / 2 inner lens)
710216	Bossweld Jet, Crew, H3, Firestorm, Armour, Neo-FX Sweatband (Pkt 2)
710315	Bossweld H3, Firestorm, Armour, Neo-FX Harness Assembly
710414	Bossweld Firestorm, Armour Side Controller

SAFETY PRECAUTIONS READ BEFORE USING



READ INSTRUCTIONS

- Read and follow all labels and Owner's Manual carefully before installing, operating, or servicing unit. Read the safety information at the beginning of the manual and in each section.
- Use only genuine replacement parts from the manufacturer.
- Perform maintenance and service according to the Owner's Manuals, industry standards, and national, state, and local codes.

SYMBOL USAGE

DANGER!-Indicates a hazardous situation which, if not avoided, will result in death or serious injury. The possible hazards are shown in the adjoining symbols or explained in the text.



NOTICE!-Indicates statements not related to personal injury. Indicates special instructions

This group of symbols means Warning! Watch Out! ELECTRIC SHOCK, MOVING PARTS, and HOT PARTS hazards. Consult symbols and related instructions below for necessary actions to avoid the hazards.

ARC WELDING HAZARDS

The symbols shown below are used throughout this manual to call attention to and identify possible hazards. When you see the symbol, watch out, and follow the related instructions to avoid the hazard. The safety information given below is only a summary of the more complete safety information found in the Safety Standards listed in Section 1-5. Read and follow all Safety Standards.

Only qualified persons should install, maintain, and repair this unit.

During operation, keep everybody, especially children, away..



ARC RAYS CAN BURN EYES AND SKIN

Arc rays from the welding process produce intense visible and invisible (Ultraviolet and infrared) rays that can burn eyes and skin. Sparks fly off from the weld.

- Wear a welding helmet fitted with a proper shade of filter to protect your face and eyes when welding or watching. Refer to Lens Shade Selection table at the bottom.
- Wear approved safety glasses with side shield under your helmet.
- Use protective screens or barriers to protect others from flash, glare, and sparks; warn others not to watch the arc.
- Wear protective clothing made from durable, flame-resistant material (leather, heavy cotton, and wool) and foot protection.
- Before welding, adjust the auto-darkening lens sensitivity setting to meet the application.
- Stop welding immediately if the auto-darkening lens does not darken when the arc is struck. See the Owner's Manual for more information.

SHADE SELECTION

Start with a shade that is too dark to see the weld zone. Then, go to a lighter shade which gives a sufficient view of the weld zone without going below the minimum.

WELDING PROCESS	ARC CURRENT (AMPERES)																					
	1.5	6	10	15	30	40	60	70	100	125	150	175	200	225	250	300	350	400	450	500	600	
SMAW					8			9		10		11		12			13		14			
MAG					8			9		10		11			12			13		14		
TIG					8		9		10		11			12		13						
MIG (Heavy)									9		10		11		12		13		14			
MIG (Light)									10				11		12		13		14			
PAC									9		10	11	12			13						
PAW	4	5	6	7	8	9	10	11		12												
Note	★ SMAW-Covered Electrodes ★ MAG-Metal Arc Welding ★ TIG-Gas Tungsten Arc Welding										★ MIG (Heavy)-MIG with Heavy Metals ★ MIG (Light)-MIG with Light Alloys ★ PAC-Plasma Jet Cutting ★ PAW-Microplasma Arc Welding											

PREPARATIONS BEFORE USE

1. Protective Films

Must remove the protective films from both the inner and outer lenses. (Page 7 Step 1)
If you don't remove them, your vision will be blurry and obscured.

2. Check Batteries

Many auto-darkening helmets rely on batteries (some are solar-assist with a battery backup).
A low or dead battery is a common cause of failure. Replace them as needed.
The batteries should be installed/replaced when the low battery indicator flashes.

3. Clean Sensors and Lenses

Dust, dirt, spatter, or smudges on the external sensors or the front cover lens can block light from reaching the sensors, preventing the helmet from darkening. Clean them regularly with a soft, lint-free cloth.

4. Check for Damage

Inspect the helmet for any cracks, deep scratches, or other physical damage, especially on the lens or around the sensors.

5. Settings

Ensure your sensitivity and shade settings are appropriate for the type of welding you intend to do.
If the sensitivity is too low, the helmet might not trigger.

6. Grind Mode

Make sure the helmet is NOT in "Grind Mode" if you expect it to darken.
Grind mode bypasses the auto-darkening function.

AUTO-DARKENING FILTER FUNCTION

1. Weld Mode

This is the primary mode for most welding processes (MIG, TIG, Stick/MMA, Flux-Cored). When an arc is struck, the helmet's sensors detect the bright light and instantly darken the lens to a range of shade **9 to 13**.

2. Cutting Mode

This mode is specifically designed for cutting processes, such as plasma cutting, oxy-fuel cutting, or air carbon arc cutting. These processes also produce intense light, but often require a slightly different shade range than welding. Cutting modes typically offer shades in the range of shade **4 to 8**.

3. Grind Mode

When activated, this mode essentially turns off the auto-darkening feature and keeps the lens in a very light state, typically around shade 3. This allows you to clearly see your work while grinding (e.g., preparing metal, cleaning welds, or sharpening electrodes) without having to remove your helmet.

4. Auto Mode

Equipped with an ambient light sensor, the AUTO function enables the filter to automatically adjust its shade number to suit the surrounding light conditions. Adjustable shade **-2 to +2**.

5. ON/OFF Function

Turn the screen off to save the battery after welding.

6. Shade Function

Controls darkness level of the lens that protects your eyes from the welding arc's intense light and radiation.

7. Sensitivity Function

Controls how much light is required to trigger the lens to darken.

8. Delay Function

Controls how long the lens stays dark after the welding arc stops.

9. Memory Function

Can save up to 10 user programs with the memory function.

10. Test Function

Self-test the ADF function before using.

11. Passive Function

Manually set and lock the lens to a specific dark shade, effectively turning the auto-darkening function off.

12. Comfort + Spot Function

Very short delay for returning to the light state after a weld. Recommended for quick tack welding and high-current welding.

AUTO-DARKENING FILTER ADJUSTMENTS

1. Selecting Modes

Press external knob MODE button or internal MODE button to select Weld or Cutting mode.

2. Selecting Grind Mode

Press and hold external knob GRIND button or press internal MODE button to select Grind mode.

3. Selecting Auto Range

Press and hold external MODE button or press internal MODE button to select AUTO mode.

4. Turn ON / OFF

Press and hold ON button to turn on / off the ADF.

5. Selecting Shade Range

Rotate external MODE knob or press internal SHADE button to select your desired shade.

6. Selecting Sensitivity Range

Press the SENSITIVITY button once to check the current range. Press the button again to choose your desired option. The left indicator bar will flash and then settle on your selected option.

7. Selecting Delay Range

Press the DELAY button once to check the current range. Press the button again to choose your desired option. The right indicator bar will flash and then settle on your selected option.

8. Selecting Memory

Press the MEMORY button to select one of the 9 programs. While the memory number is flashing, adjust your parameters. The program will save automatically once the number stops flashing.

9. Selecting Test

Press and hold TEST button, it will start testing a range of shade in WELD, CUTTING and GRIND.

10. Selecting Comfort Function

Press COMFORT button once to turn on COMFORT mode. Press it again to turn off.

11. Selecting Passive Function

Press and hold Passive button until the green light indicator flashes. Press and hold it again to deselect. Or select Passive function using external MODE button.

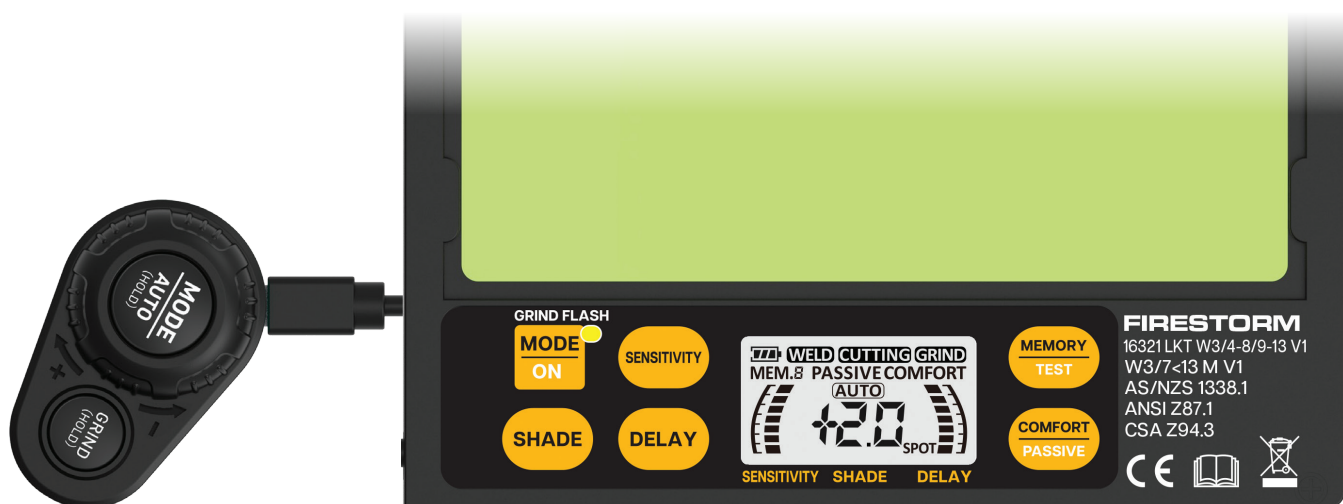

- ⚠ If the auto-darkening filter does not function as described above, do not use, check trouble shooting guide in this manual or contact Bossweld service support (details in back of manual).
- ⚠ The auto-darkening filter may not turn dark if the sensors are blocked or the welding arc is totally shielded. Flashing light sources (e.g. safety strobe lights) can trigger the auto-darkening filter making it flash when no welding is occurring. This interference can occur from long distances and/or from reflected light. Welding areas must be shielded from such interference.
- ⚠ The auto-darkening filter will automatically turn off after a period of inactivity.

HELMET ADJUSTMENTS

1. Adjusting the Headgear Tightness

- To adjust the headgear's top for a proper fit, push the small button through the current slot, slide it to the desired slot, and snap the small button into place (A).
- Adjust the headgear by turning the adjusting wheel (B) to match your head circumference.
- Once you've put on the helmet, move your head to ensure it sits securely and stably.

2. Adjusting the Distance Between the Filter and the Face

- Press down and hold the buttons on both sides (C) so the headgear can be slide back and forth.
- Release the buttons to snap the pins into slots. Make sure the distance between the lens to
- both eyes are the same.

3. Adjusting the Viewing Angle

- Loosen the right block nut.
- Adjust the viewing angle with the pins on the angle limitation washer.
- Press up the pin to adjust into the desired slot on the right boot screw (D).
- Re-tighten the right block nut.



4. Head Harness Assembly

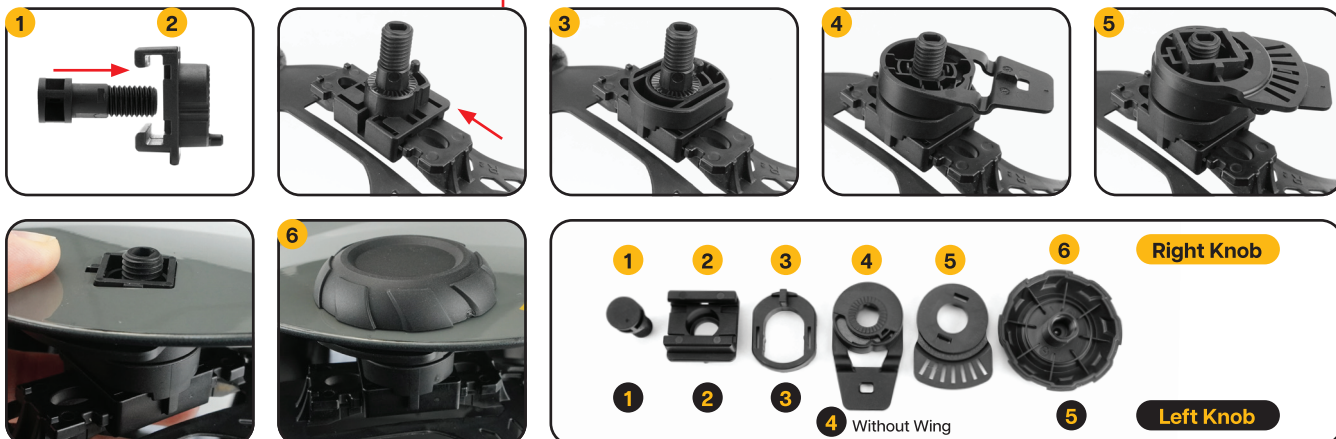

1. Replacing the Cover Lens

- Unlock the Auto-darkening filter cartridge holder by pushing the button to the right.
- Lift the cartridge holder to take out the outer lens.
- For inner lens, place your fingernail in recess above the filter view window and flex lens upwards until it releases from edges of filter view window.

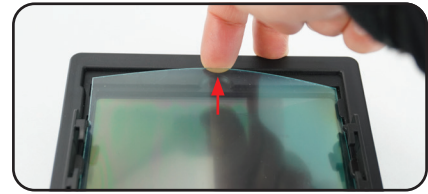
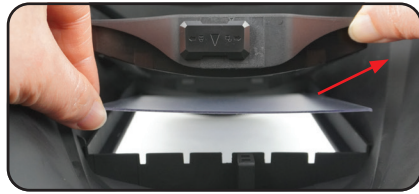
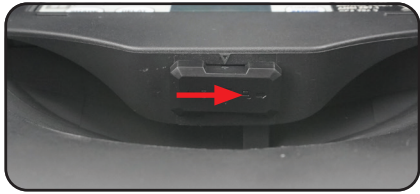

- Remove protective film on cover lens.
- Simply place the outer lens into the same position.
- For the inner lens, insert the left edge first. Then, tilt the inner lens upward to push the right edge into place.

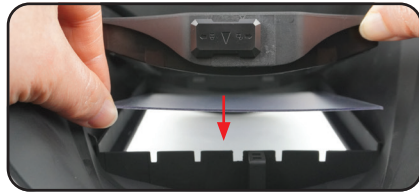
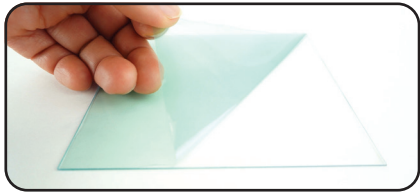

2. Replacing the Auto-darkening Filter

- Disconnect the auto-darkening filter plug from the switch to remove the cartridge holder from the helmet.
- To remove the cartridge from the holder, press the top of the holder clip outward to release the cartridge.
- To replace, follow the reverse steps.

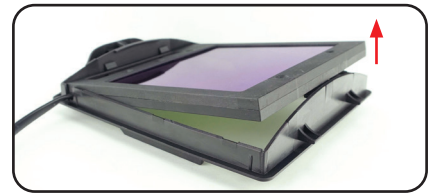
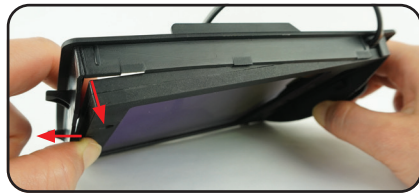
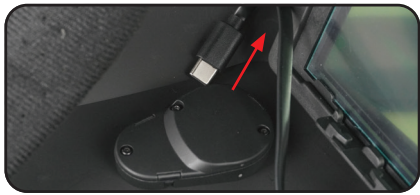

3. Replacing Batteries

Slide the battery holder out of the auto darkening filter (remove the used battery when replacing battery), put 2 new CR2032 battery inside the battery holder, and put the battery holder back into the auto darkening filter. Please make sure the anode and cathode of the battery are installed correctly.

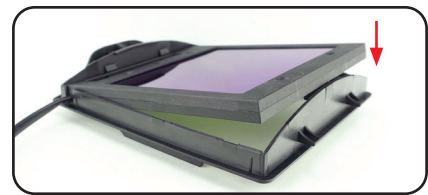

4. Changing the Sweatband

- Remove the old sweatband from the headgear.
- Wrap a new sweatband around the front headgear, then each hole secures onto the pin.



CLEANING & STORAGE

- Clean the welding helmet with mild soap and lukewarm water.
- Use mild disinfection solution to disinfect the protector. Do not use solvents.
- Clean the auto-darkening filter with a clean, lint-free tissue or cloth.
- Do not immerse auto-darkening filters in water or spray directly with liquids.
- Store the welding visor fully assembled in a place that is dry and free of dirt.
- Protect from direct sunlight and thermal radiation.
- Switch to grind mode when not in use. This will prolong the battery life.

TROUBLE-SHOOTING GUIDE

FAULT	CAUSE	REMEDY
The auto-darkening filter flickers or does not auto-darken	Low battery level	Replace the batteries
	The outside cover lens is dirty	Replace the outside cover lens
	Dirty arc sensors	Clean the arc sensors
	Low welding current	Use a higher sensitivity setting
Darkening is uneven	The distance between eyes and auto-darkening filter is different for each eye	Check the headgear settings
The response time is too long	The ambient temperature is too low	Use only within the specified temperature range (above -10 °C or 14 °F)
Poor vision quality	The outside cover lens is dirty or scratched	Clean or replace the outside cover lens
	The wrong shade number was selected	Select the right shade number
	The protective film has not been removed	Remove the protective film
Welding helmet slips	Incorrect headgear settings	Adjust the headgear

WARRANTY

For service support please call (02) 8761 6500. In order to make a claim under warranty you must return the product to the original place of purchase along with your purchase receipt. Faulty goods should be returned in their original packaging along with any supplied accessories.

2 YEAR WARRANTY

Your product is guaranteed against manufacturing workmanship or defect for a period of 24 months from the original date of purchase. This warranty covers manufacturing defects in materials, workmanship and finish under normal use. If a product is found to be defective we reserve the right to repair or replace at our sole discretion.

No responsibility will be taken for products lost, damaged or mislaid whilst in transit.

To the extent permitted by law this warranty does not cover any indirect or consequential losses and our total liability, if any, shall be limited to the amount paid for the product by you to the retailer.

The benefits provided under this warranty are in addition to other rights and remedies which are available to you under Australian law.

WARRANTY EXCLUSIONS

The following actions will result in the warranty being void:

- Damage, faults or defects arising from misuse, abuse accidents or alterations
- Failure to perform maintenance or maintain good working condition.
- If the any modifications are made.
- Fair wear and tear.

This warranty is given by Dynaweld Industrial Supplies Pty Ltd

Ph.1300 899 710

Australia (Head Office): 2/10 Jessica Place, Prestons, NSW, Australia, 2170

Scan to Learn More

