



X series

MST

MIG • STICK • TIG Inverter

**MULTIPROCESS
DC INVERTER MANUAL**

250XT / 350XT



BOSSWELD

WELD LIKE A BOSS

X series

Thank you for choosing a BOSSWELD MST 250/350XT Inverter DC MIG Welder

In this manual you will find instructions on how to set up your welder along with general welding information, safety information and helpful tips. We encourage you to go online to our website for more tips and troubleshooting as well as many welding resources.

The BOSSWELD MST 250/350XT is the latest in IGBT multipurpose welder technology, this very portable power source enables the user to complete high quality welds in both MIG - TIG - MMA/Stick electrode applications.

This welder is easy to set up, easy to use and will provide very smooth output.

We truly hope you enjoy using your welder!



M

MIG

- Simple to learn
- MIG Wire is fed through the gun to create the weld pool
- Gas or flux prevents oxidation in the weld
- Weld with or without gas
- Point and pull the trigger
- Great for maintenance, small projects & automotive repairs

METAL TYPES

Mild steel, stainless steel & aluminium

S

STICK

- Easiest process to learn
- Best choice for quick repairs
- Slower than MIG welding
- Forgiving in dirty/rusty environments
- Not recommended for thin sheet metal welding

METAL TYPES

Mild steel, stainless steel & cast iron

T

TIG

- Gives a better weld finish
- Accurate heat control
- Considered the most challenging process to learn
- Good way to weld thin material
- Argon gas is required

METAL TYPES

Mild steel, stainless steel



CONTENTS	PAGE
WARRANTY	4
BOX CONTENTS	5
WARNINGS	6
MACHINE CARE / SAFETY INSTRUCTIONS	7
WORK AREA SAFETY	8
MAINTENANCE & DISPOSAL / GAS BOTTLE	9
MACHINE SPECIFICATIONS	10-11
FRONT & REAR PANEL LAYOUT	12
MACHINE CONTROLS PANEL	13
MACHINE INSIDE / DUTY CYCLE	14-15
WIRE SPOOL & WIRE FEED SET UP	16
MIG TORCH SETUP	17
LINER INSTALLATION / REPLACEMENT	18
DRIVE ROLLER SIZE	19
2T / 4T TRIGGER CONTROL INFORMATION	19
MIG TORCH AND CONSUMABLE CARE	20
STICK / MMA WELDING SETUP	21-22
GENERAL MMA WELDING	23
GASLESS MIG WELDING SETUP	24-26
GAS MIG WELDING SETUP	26-29
SPOOL GUN WELDING SETUP	30-33
GENERAL MIG WELDING	34-37
TIG WELDING SETUP	38-39
OPTIONAL REMOTE CURRENT SET UP	40
TUNGSTEN PREPARATION	41
GENERAL TIG WELDING	41-42
BZ24 MIG TORCH PARTS BREAK DOWN	43
BZ36 MIG TORCH PARTS BREAK DOWN	44
26 TIG TORCH PARTS BREAKDOWN	45
SPOOL GUN PARTS BREAKDOWN	46
HELPFUL INFORMATION & TROUBLE SHOOTING	47-50



WARRANTY

This warranty is in addition to the statutory warranty provided under Australian Consumer Law, but does not include damage resulting from transport, misuse, neglect or if the product has been tampered with.

The product must be maintained as per this manual, and installed and used according to these instructions on an appropriate power supply. The product must be used in accordance with industry standards and acceptable practice.

This warranty covers the materials used to manufacture the machine and the workmanship used to produce the item. This Warranty does not cover damage caused by:

1. Normal wear and tear due to usage
2. Misuse /abuse or Neglect of the item
3. Transport / handling breakages
4. Lack of maintenance, care and cleaning
5. Environmental factors, such as usage in temperatures exceeding 40 degrees, above 1000mt sea level, rain, water, excessive damp, cold or humid conditions.
6. Improper setup or installation
7. Use on Incorrect voltage or non authorised electrical connections and plugs
8. Use of non standard parts
9. Repair, case opening, tampering with, modifications to any part of the item by non authorised BOSSWELD repairers.

This warranty covers the machine only and does not include Torches, Leads, Earth Clamps, Electrode holders, Plasma Torches, Tig Torches and any of the parts on those items unless there is a manufacturing fault.

1. REGISTRATION

Purchasers are encouraged to register for warranty on our website. www.bossweld.com.au/warranty

Product must be registered to receive full 5 year warranty. 3 year standard warranty applies if the product is not registered online.

2. TIME PERIOD - 3 Years (*when registered online*)

When the welder *has been registered online*, a warranty claim must be made within 5 years from the date of purchase. If the welder *has not been registered online*, a warranty claim must be made within 3 years from the date of purchase. Any claim must include proof of purchase.

3. HOW TO MAKE A CLAIM - NEED SOME HELP?

- Visit our website www.bossweld.com.au/troubleshooting for many helpful tips and guides to assist with the setup and usage of your new machine. Still stuck....?
- Call the BOSSWELD Helpdesk on 1300 899 710 for over the phone assistance.
- If the machine is not operational then return the item to the place of purchase.

Note:

If this welders duty cycle is exceeded the welder will enter “thermal overload” which will automatically stop the welding output in order to protect, both the user and the welder. You will know the welder has gone into thermal overload when the overload error indicator light is illuminated. The welder will then cool itself down, and once the overload error indicator light is no longer illuminated, welding can then re-commence. Please note. Exceeding the machine’s duty cycle, cannot be considered grounds for warranty or return.

BOSSWELD MAKES NO OTHER WARRANTY, EXPRESS OR IMPLIED. THIS WARRANTY IS EXCLUSIVE AND IN LIEU OF ALL OTHERS, INCLUDING, BUT NOT LIMITED TO ANY WARRANTY OF MERCHANTABILITY OR FITNESS FOR ANY PARTICULAR PURPOSE.

BOSSWELD MST 250/350XT Multi-Process Inverter Welder Box Contents

1. BOSSWELD MST 250/350XT Inverter DC MIG Welder
2. 4 metre 24 Series MIG Torch (250XT only)
2. 4 metre 36 Series MIG Torch (350XT only)
3. 3 metre twist lock electrode holder
4. 3 metre Earth cable with earth clamp
5. 2 metre Gas Hose
6. Twin Gauge Argon Regulator
7. Drive Rollers (not shown)
8. Operating Manual (not shown)



Note: Pictures may vary from your machine model



WARNING

The device and packaging material are not toys! Children must not be allowed to play with the machine and its accessories. Plastic parts and packaging are choking risks for children.

- Open the packaging and remove the welder carefully.
- Check that the delivery is complete.
- If possible, store the packaging until the warranty period has expired.

PERSONAL PROTECTIVE EQUIPMENT (PPE)



GLOVES AND PROTECTIVE CLOTHING

Use protective gloves and fire resistant protective clothing when welding. Avoid exposing skin to ultraviolet rays produced by the arc.



WELDING HELMET

Under no circumstances should the welder be operated unless the operator is wearing a welding helmet to protect the eyes and face. There is serious risk of eye damage if a helmet is not used. The sparks and metal projectiles can cause serious damage to the eyes and face. The light radiation produced by the arc can cause damage to eyesight, and burns to skin. Never remove the welding helmet whilst welding.



SAFETY GLASSES

After welding use appropriate safety glasses when brushing, chipping or grinding the slag from the weld.



OTHER PERSONS

Ensure that other persons are screened from the welding arc and are at least 15 metres away from the work piece. Always ensure that the welding arc is screened from onlookers, or people just passing by. Use screens if necessary, or non-reflecting welding curtain. Do not let children or animals have access to the welding equipment or to the work area.



SWITCHING OFF

When the operator has finished welding they must switch the welder off.

DO NOT put the electrode holder down with the welder switched ON.

When leaving the welder unattended, move the ON/OFF switch to the OFF position and disconnect the welder from the electrical mains supply.

Do not leave hot material unattended after welding.



FUMES & GASES ARE DANGEROUS

Smoke and gas generated whilst welding or cutting can be harmful to people's health. Welding produces fumes and gases. Breathing these fumes and gases can be hazardous to your health.

- Do not breathe the smoke and gas generated whilst welding or cutting, keep your head out of the fumes
- Keep the working area well ventilated, use fume extraction or ventilation to remove welding fumes and gases.
- In confined or heavy fume environments always wear an approved air-supplied respirator. Welding fumes and gases can displace air and lower the oxygen level causing injury or death. Be sure the breathing air is safe.
- Do not weld in locations near de-greasing, cleaning, or spraying operations. The heat and rays of the arc can react with vapours to form highly toxic and irritating gases.
- Materials such as galvanized, lead, or cadmium plated steel, containing elements that can give off toxic fumes when welded. Do not weld these materials unless the area is very well ventilated, and or wearing an air supplied respirator.



MACHINE CARE / SAFETY

Keep the welding cables, earth clamp and electrode holder in good condition. Failure to do this can result in poor welding quality, which could be dangerous in structural situations.

Prior to use, check for breakage of parts and any other conditions that may affect operation of the welder. Any part of the welder that is damaged should be carefully checked to determine whether it will perform its intended function whilst being safe for the operator. Any part that is damaged should be properly repaired, or replaced by an authorised service centre.

IMPROPER USE

It is hazardous to use the welding machine for any work other than that for which it was designed e.g. do not use welder for thawing pipes.

HANDLING

Ensure the handle is correctly fitted. As welding machines can be heavy, always use safe lifting practices when lifting.

POSITION AND HANDLING

To reduce risk of the machine being unstable / danger of overturning, position the welding machine on a horizontal surface that is able to support the machine weight. Operators **MUST NOT BE ALLOWED** to weld in raised positions unless safety platforms are used.



SAFETY INSTRUCTIONS

WARNING

The user of this welder is responsible for their own safety and the safety of others. It is important to read, understand and respect the contents of this user guide. When using this welder, basic safety precautions, including those in the following sections must be followed to reduce the risk of fire, electric shock and personal injury. Ensure that you have read and understood all of these instructions before using this welder.

Persons who are not familiar with this user guide should not use this welder. Keep this booklet in a safe place for future reference.

TRAINING

The operator should be properly trained to use the welding machine safely and should be informed about the risks relating to arc welding procedures. This user guide does not attempt to cover welding technique. Training should be sought from qualified / experienced personnel on this aspect, especially for any welds requiring a high level of integrity for safety.





SERIOUS FIRE RISK

The welding process produces sparks, droplets of fused metal, metal projectiles and fumes.

This constitutes a serious fire risk. Ensure that the area in which welding will be undertaken is clear of all inflammable materials. It is also advisable to have a fire extinguisher, and a welding blanket on hand to protect work surfaces.



WORK AREA

-  Ensure a clear, well lit work area with unrestricted movement for the operator.
-  The work area should be well ventilated, as welding emits fumes which can be dangerous.
-  Always maintain easy access to the ON/OFF switch of the welder, and the electrical mains supply.
-  Do not expose the welder to rain and do not operate in damp or wet locations

Where welding must be undertaken in environments with increased risk of electric shock, confined spaces or in the presence of flammable or explosive materials, it is important that the environment be evaluated in advance by an “expert supervisor”. It is also recommended that welding in these circumstances be carried out in the presence of persons trained to intervene in emergencies.

AVOID ELECTRICAL CONTACT

Use adequate electrical insulation with regard to the electrode, the work piece and any accessible earthed metal parts in the vicinity. Avoid direct contact with the welding circuit. The no load voltage between the earth clamp and the electrode can be dangerous under certain circumstances.

Note: For additional protection from electric shock. It is recommended that this welder be used in conjunction with a residual current device (RCD) with rated residual current of 30MA or less.

In general the use of extension leads should be avoided. If used however, ensure that the extension lead is used with the welder is of a suitable current rating and heavy duty in nature that **MUST** have an earth connection. If using the welder outdoors, ensure that the extension lead is suitable for outdoor use. Always keep extension leads away from the welding zone, moisture and any hot materials.

WELDING SURFACES

Do not weld containers or pipes that hold, or have held, flammable liquids or combustible gases or pressure. Do not weld on coated, painted or varnished surfaces as the coatings may ignite, or can give off dangerous fumes.

WORK PIECE

When welding, the work piece will remain at high temperature for a relatively long period. The operator must not touch the weld or the work piece unless wearing welding gloves. Always use pliers or tongs. Never touch the welded material with bare hands until it has completely cooled.

VOLTAGE BETWEEN ELECTRODE HOLDERS OR TORCHES

Working with more than one welding machine on a single work piece, or on work pieces that are connected, may generate a dangerous accumulation of no-load voltage between two different electrode holders or torches, the value of which may reach double the allowed limit.



MAINTENANCE

WARNING

Before starting any cleaning, or maintenance procedures on the welding machine, make sure that it is switched OFF and disconnected from the mains supply.

There are no user serviceable parts inside the welder. Refer to a qualified service personnel if any internal maintenance is required. After use, wipe the welder down with a clean soft dry cloth.

Regular inspection of the supply cord is required and if damaged is suspected, it must be immediately replaced by the manufacturer, its service agent or similarly qualified persons in order to avoid a hazard

STORAGE/ TRANSPORT

Store the welder and accessories out of children's reach in a dry place. If possible store the welder in the original packaging. The appliance must unconditionally be secured against falling or rolling over during transport.



DISPOSAL

DISPOSING OF THE PACKAGING

Recycling packaging reduces the need for landfill and raw materials. Reuse of the recycled material decreases pollution in the environment. Please recycle packaging where facilities exist. Check with your local council authority for recycling advice.

DISPOSING OF THE WELDER

Welders that are no longer usable should not be disposed of with household waste but in an environmentally friendly way. Please recycle where facilities exist. Check with your local council authority for recycling advice.



GAS BOTTLE

ATTENTION! - CHECK FOR GAS LEAKS

At initial set up and at regular intervals we recommend to check for gas leakage

Recommended procedure is as follows:

1. Connect the regulator and gas hose assembly and tighten all connectors and clamps.
2. Slowly open the cylinder valve.
3. Set the flow rate on the regulator to approximately 10-15 l/min.
4. Close the cylinder valve and pay attention to the needle indicator of the contents pressure gauge on the regulator, if the needle drops away towards zero there is a gas leak. Sometimes a gas leak can be slow and to identify it will require leaving the gas pressure in the regulator and line for an extended time period. In this situation it is recommended to open the cylinder valve, set the flow rate to 8-10 l/min, close the cylinder valve and check after a minimum of 15 minutes. Ensuring adequate ventilation fore small spaces.
5. If there is a gas loss then check all connectors and clamps for leakage by brushing or spraying with / soapy water, bubbles will appear at the leakage point.
6. Tighten clamps or fittings to eliminate gas leakage.

IMPORTANT! - We strongly recommend that you check for gas leakage prior to operation of your machine. We recommend that you close the cylinder valve when the machine is not in use. BOSSWELD, authorised representatives or agents of BOSSWELD will not be liable or responsible for the loss of any gas.

MST250XT

Inverter Welder

The Bossweld MST 250XT is a multi-process, inverter-based welder that provides the opportunity to MIG, Stick and TIG weld from the same machine. Heavy duty and designed for industrial use; the 250 Amps at 60% delivers ample power, and the front swivel wheels make it easy to manoeuvre.

FEATURES

- Single phase 240V
- 250 Amp output
- MIG /Stick /TIG welder
- Suitable for industrial
- Digital LED display
- 4 Roll wire drive system
- Stepless adjustment control
- Gas /gasless operation
- 2T / 4T trigger latching
- Excellent arc stability
- Gun/lead hanger
- Suits D200/D300 spools
- Spool gun ready

PROCESS

- Gas and gasless MIG welding
- DC Stick (MMA) welding
- DC TIG welding lift arc

OPTIONS/UPGRADES

- AS Approved 15A 240V HD plug
- Bossweld Arc lead set
- Aluminium Upgrade Kit (1.0/1.2mm rollers/4mt Teflon liner)
- Bossweld Spool Gun
- Bossweld 26 Series TIG Torch

Primary Input power	Single Phase 240V 50-60 HZ +/-15%
Duty Cycle @ 40°C	250A @ 40%*
Open Circuit Voltage	MIG 58V TIG 14V MMA 14V
Output Current Range	MIG: 50-250Amps MMA / TIG: 10-250Amps
I Max	MIG 50.6A TIG 39.6A MMA 57.1A
I eff	32 Amps (250A @ 40%) 15 Amps (200A @ 15%)**
Protection/Insulation Class	IP21S / S
Wire Diameter Range	0.8mm to 1.6mm
Electrode Diameter Range	2.5mm to 5.0mm
Thermal Overload	Yes
Minimum KVA	12.5
Dimensions/Weight	87 x 90 x 48cm / 51.2kg



* The I eff is used to determine the mains cable size and supply requirements.

** For use with a 15amp mains supply the reduced duty cycle limit applies. (See installation notes on page 15)

MST350XT

Inverter Welder

The Bossweld MST 350XT is a multi-process, inverter-based welder that provides the possibility to MIG, Stick and TIG weld from the same machine. Heavy duty and designed for industrial use, the 285 Amps at 60% provides ample power, and the front swivel wheels make it easy to manoeuvre.

FEATURES

- 350 Amp output
- MIG /Stick /TIG welder
- Suitable for industrial
- Digital LED display
- 4 Roll wire drive system
- Stepless adjustment control
- Gas /gasless operation
- 2T / 4T trigger latching
- Excellent arc stability
- Gun/lead hanger
- Suits D200/D300 spools
- Spool gun ready

PROCESS

- Gas and gasless MIG welding
- DC Stick (MMA) welding
- DC TIG welding lift arc

OPTIONS/UPGRADES

- AS Approved 20A 3 Phase plug
- Bossweld Arc lead set
- Aluminium Upgrade Kit (1.0/1.2mm rollers/4mt Teflon liner)
- Bossweld Spool Gun
- Bossweld 26 Series TIG Torch

Primary Input power	3 Phase 415V 50-60 HZ +/-15%
Open Circuit Voltage	MIG 55V TIG 14V MMA 14V
Output Current Range	MIG: 40-350Amps MMA/TIG: 10-300Amps
I Max	MIG 26.8A TIG 16.5A MMA 23A
I eff	MIG 16.9A TIG 10.4A MMA 14.5A
Protection/Insulation Class	IP21S / S
Wire Diameter Range	0.8mm to 1.6mm
Electrode Diameter Range	2.5mm to 5.0mm
Thermal Overload	Yes
Minimum KVA	20.0
Dimensions/Weight	87 x 90 x 48cm / 52kg
Duty Cycle @ 40°C	MIG: 60% @ 285A MMA/TIG: 60% @ 245A



FRONT PANEL

1. Control Panel
2. MIG Torch Connection Socket
3. Positive Output Connection Socket
4. Polarity Cable
5. Gas Output Connection
6. Remote Controller Plug
7. Negative Output Connection Socket



REAR PANEL

8. Gas Cylinder Securing Chain
9. Mains Power Cord
10. Cooling Fan
11. Gas Input

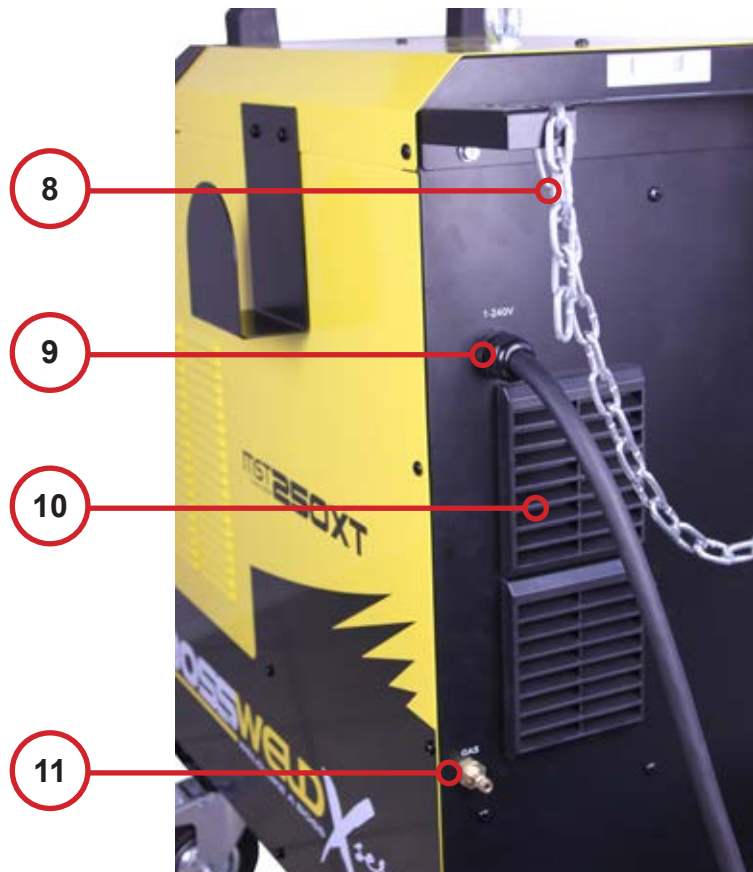



- 1 Welding Method**
Press to select MIG / Stick MMA / TIG Lift Arc
- 2 Current / wire feed speed Display**
 - Displays the Welding current in Amps. (when 6 is lit) MMA
 - Displays Wire Speed in Meters per Min (when 5 is lit) MIG
- 3 Wire Speed LED**
Use current setting knob to set the wire speed (MIG)
- 4 Amperage LED**
Illuminates when TIG / MMA amperage is active.
- 5 Voltage, Arc Force Display**
 - Displays the Welding voltage when machine is in MIG
 - Displays the Arc Force when machine is in Stick / MMA
 - Displays the downslope current at the end of the weld. TIG only
- 6 Voltage LED**
Illuminates when Voltage selection is on, use Voltage setting knob to adjust voltage
- 7 ARC Force LED**
When the Arc Force LED is on you can use the voltage setting knob to set the ARC Force (MMA)
- 8 Power LED**
Illuminates when Power is on.
- 9 Overload Error Indicator**
Illuminates when the machine is overloaded
- 10 Downslope**
Adjust the downslope current - TIG Only
- 11 Main Power ON/OFF**
Turns machine power on and off
- 12 Wave Control Knob**
The wave control setting on a MIG welder controls the rate of current rise. following the short-circuit state. That is during the time when the wire is short circuiting into the weld puddle.
- 13 Manual Wire & Gas Check Switch**
Up for Manual wire feeding, down for Gas check
- 14 Welding Mode**
Press to select 2T or 4T
- 15 Welding Current / Amps Wire Speed Adjustment Knob**
 - Set the Welding Current in Amps MMA
 - Set the Wire Speed in Meters per Minute
- 16 Welding Voltage / Arc Force**
 - Set Welding Volts in MIG mode
 - Adjust Arc Force in Stick / MMA mode
 - Adjust Downslope
- 17 Spool gun Switch**
Select spool gun mode on or off
- 18 Remote Switch**
Select TIG torch remote mode on or off

SIDE PANEL (DOOR OPEN)

- A. Spool Hub
- B. Spool Hub Nut
- C. Wire Feed Tensioning Adjustment
- D. Idle Rollers / Wire Tensioning Arms
- E. Drive Roller Retainer Nut
- F. Wire Guide Inlet Tube
- G. Wire Inlet
- H. Burnback, Slow Feed, Post Flow, Pre-Flow Adjustment Panel
- I. Storage Compartment

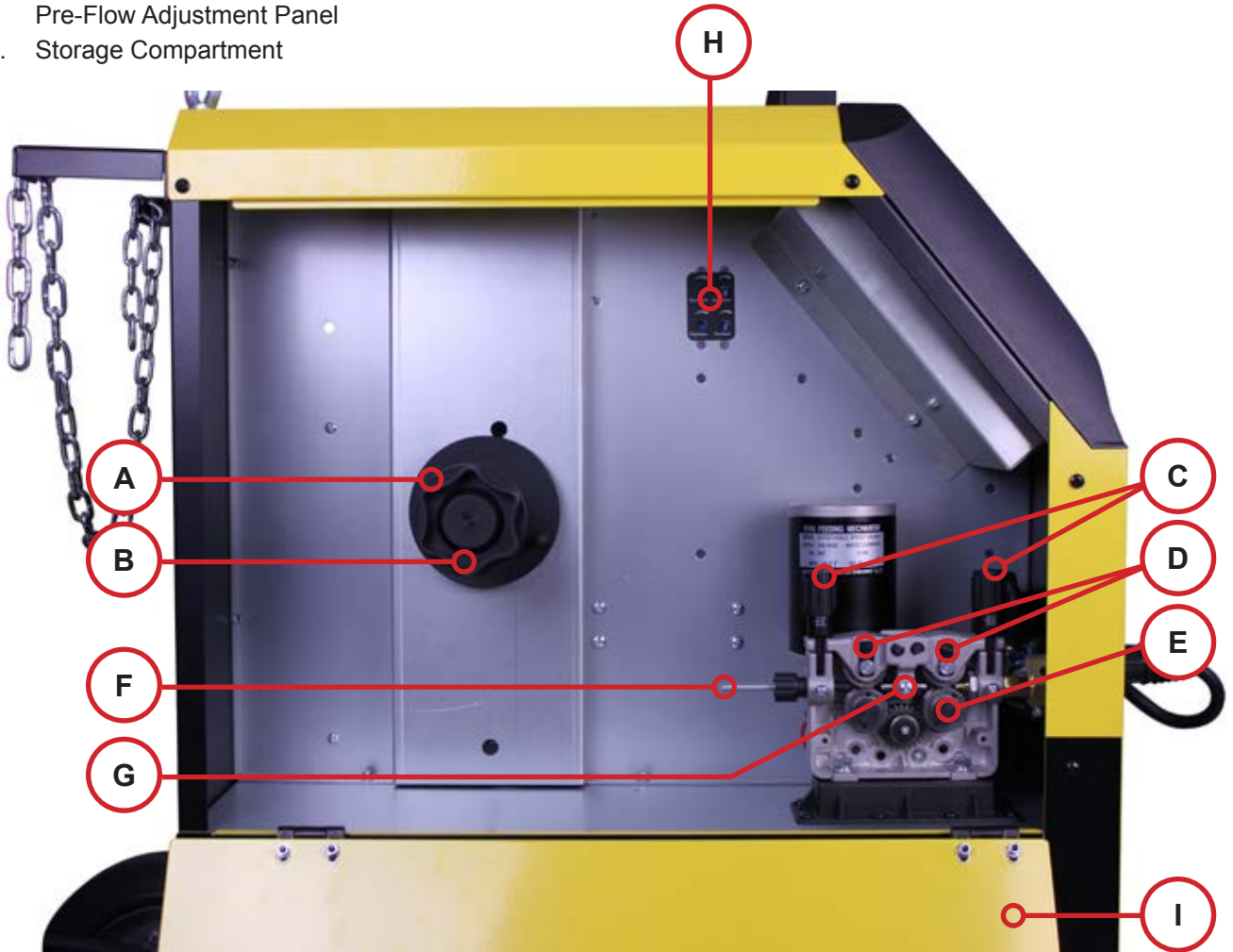

SETTING MACHINE POLARITY

DCEN - GASLESS	DCEP - GAS



C
DCEN
Polarity Switching Terminal Set for **Gasless** Welding



C
DCEP
Polarity Switching Terminal Set for **Gas** Welding

DUTY CYCLE:

Special note:

If this welders duty cycle is exceeded the welder will enter “thermal overload” which will automatically stop the welding output in order to protect, both the user and the welder. You will know the welder has gone into thermal overload when the overload error indicator light is illuminated. The welder will then cool itself down, and once the overload error indicator light is no longer illuminated, welding can then re-commence.

Please note. Exceeding the machine’s duty cycle, cannot be considered grounds for warranty or return.

The term duty cycle indicates the percentage welding time available at the output current for each 10 min period over 4 hours,

The specification plate on the machine list three given ratings at a given current and voltage.

NOTE MIG SETTINGS SHOW BELOW : Amps refer to the Current setting

10%	60%	100%
180 - Amps	65-Amps	50-Amps
23.0 Volts	17.3 Volts	16.5 Volts

For example this means when the machine is set at its highest current of 180 Amps it can weld for 1 minute in a Ten minute period. The power source is protected by a built in temperature protection device, This will activate if the machine is operated in excess of its amperage and duty cycle rating.

Xseries	mst250XT INVERTER DC MIG WELDER		
PART NO.	699625		
STANDARD	EN 60974-1:2012		
	50A/16.5V-250A/26.5V		
X	40%	60%	100%
I₂	250A	205A	160A
U₂	26.5V	24.3V	22V
U₀	58.1V	U₁ =240V	I_{1max} =50.6A I_{1eff} =32.0A
	10A/10.4V-250A/20V		
X	60%	100%	
I₂	250A	195A	
U₂	22V	17.8V	
U₀	14V	U₁ =240V	I_{1max} =39.6A I_{1eff} =30.7A
	10A/20.4V-250A/30V		
X	30%	60%	100%
I₂	250A	180A	140A
U₂	30V	27.2V	25.6V
U₀	14V	U₁ =240V	I_{1max} =57.1A I_{1eff} =31.3A

Duty Cycle
Amp/Current
Voltage

Xseries	mst350XT INVERTER DC MIG WELDER		
PART NO.	699635		
STANDARD	EN 60974-1:2012		
	40A/16V-350A/31.5V		
X	40%	60%	100%
I₂	350A	285A	225A
U₂	31.5V	28.3V	25.3V
U₀	54.2V	U₁ =400V	I_{1max} =26.8A I_{1eff} =16.9A
	10A/10.4V-300A/22V		
X	40%	60%	100%
I₂	300A	245A	190A
U₂	22V	19.8V	17.6V
U₀	56.5V	U₁ =400V	I_{1max} =16.5A I_{1eff} =10.4A
	10A/20.4V-300A/32V		
X	40%	60%	100%
I₂	300A	245A	190A
U₂	32V	29.8V	27.6V
U₀	55.8V	U₁ =400V	I_{1max} =23A I_{1eff} =14.5A

Duty Cycle
Amp/Current
Voltage

Installation: MST 250XT

- Connection to mains power supply

For use up to the maximum rated output of 250 amps @ 40% duty cycle the unit should be fitted with a 240 volt single phase plug of 32 amps capacity or greater and connected to a supply circuit with a 32 amp capacity, or greater, which is protected by a suitably rated motor start fuse or circuit breaker.

- Connection to 15 Amp Supply Circuits

For use on a 15 amp supply circuit the maximum output rating available to maintain an left of 15 amps is reduced to 200amps @ 15% duty cycle.

Ensure the supply circuit is protected by a suitably rated circuit breaker or motor start fuse.

Note: all electrical work must only be undertaken by suitably qualified personnel. Check your local requirements regarding all electrical installations.

MST 350XT

- Connection to mains power supply

The MST 350XT should be fitted with a 415 volt 3 phase plug of 15 amp capacity, or greater, and requires connection to a 415 volt 3 phase power supply with a capacity of 15 amps, or greater, which is protected by suitably rated circuit breaker or motor start fuse.

SET UP OF WIRE SPOOL & WIRE FEED UNIT

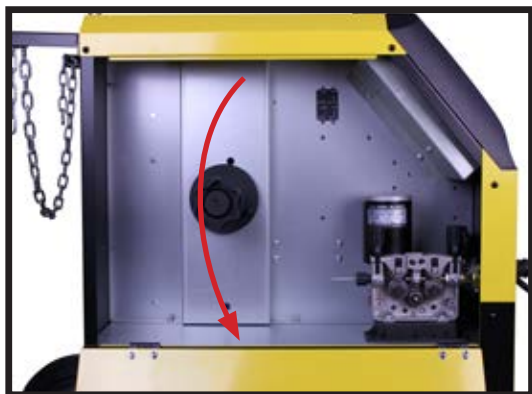

1 Open the side door of the machine.

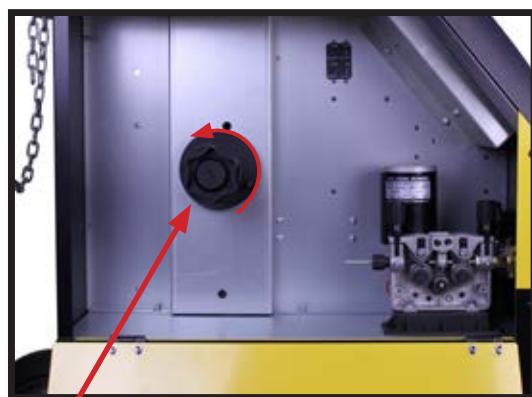

2 Remove the Spool Hub Nut and place spool of wire on Spool Hub. **Note:** Wire to roll from over spool into wire feeder

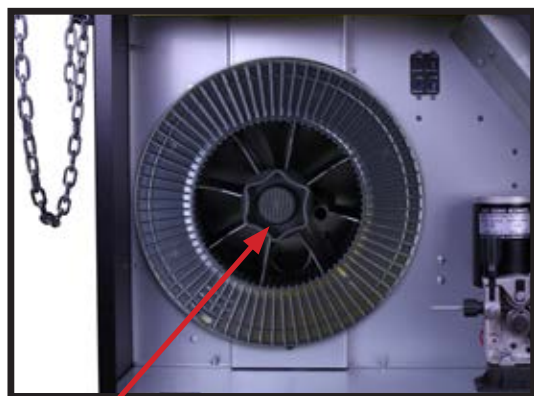

3 Replace Spool Hub Nut and adjust firmly - without too much pressure.

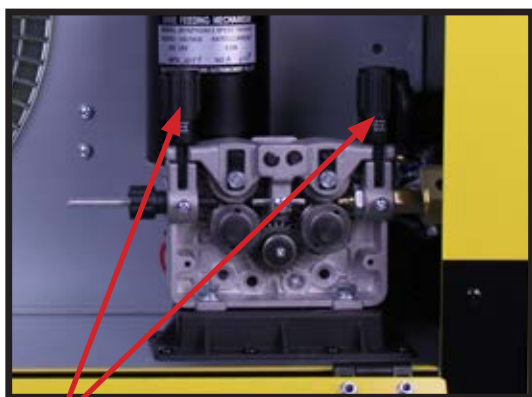

4 Release the Wire Feed Tensioning Knob by pulling it to the left.

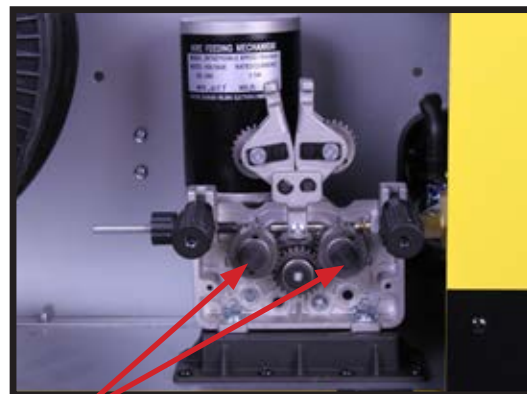

5 Remove the Drive Roller Covers. Check the Drive rollers are matched to the wire size for the job **Note:** Correct wire side on roller to face into machine when fitting. Then replace the Drive Roller Cover.

See Page 19 for drive roller size and type.

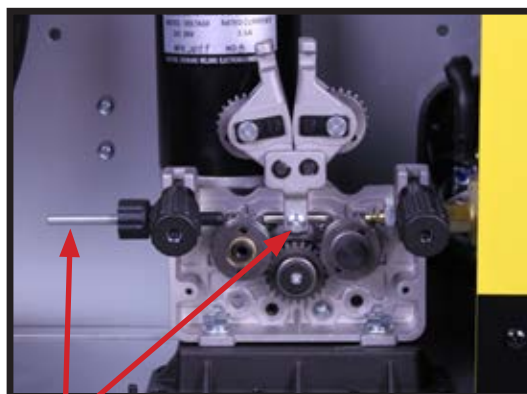
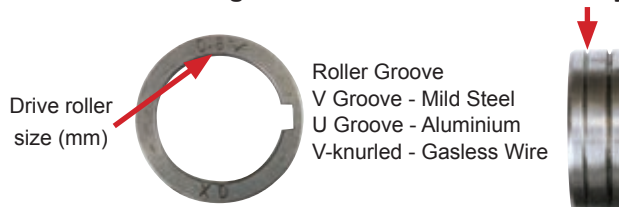

6 Take the end of the wire and feed into the Guide tube until it passes to the Inlet Tube, and out of the Euro connection Approx 3-5cm.

Ensure you hold the spool and check tension to stop wire spool unraveling

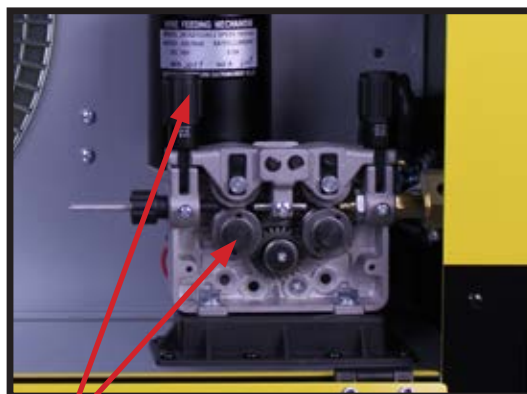

7 Replace Drive Roller Covers. Put down Wire Tensioning Arms so they lock into position, and turn the Wire Feed Tensioning Knobs to gently tighten.

Note: Pictures may vary from your machine model

SET UP OF MIG TORCH

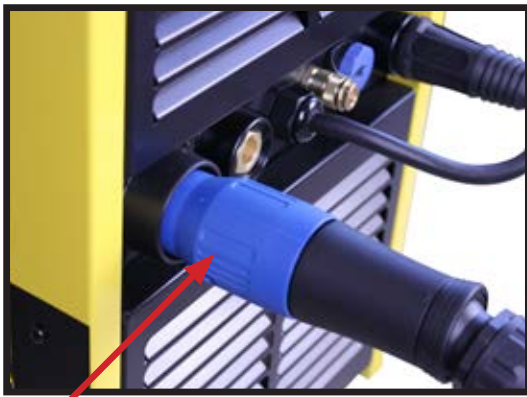

1 Attach the Euro Connect MIG torch to the machine feeding the wire into the liner.

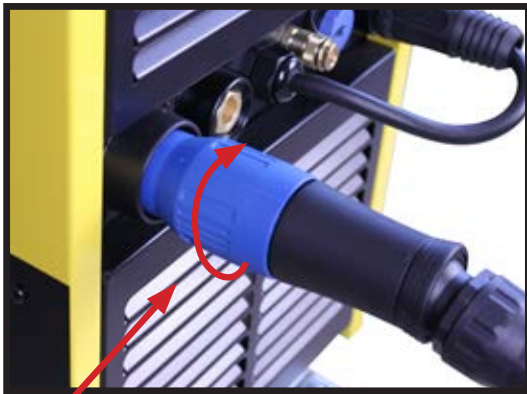

2 Tighten MIG Torch connector to machine.

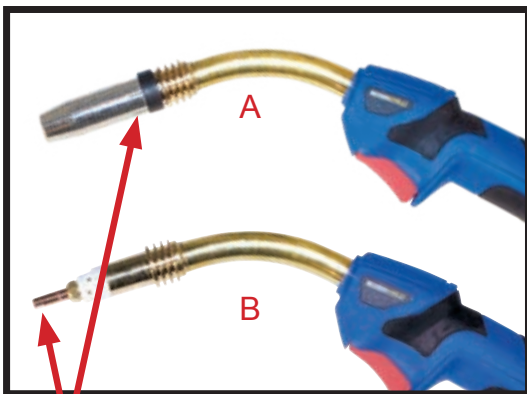

3 Remove nozzle (A) and tip (B) from torch.



4 Plug machine into appropriate power source (see below) and switch to the ON position on the control panel.
250XT: 240V, 15A. 350XT: 415V 3 Phase

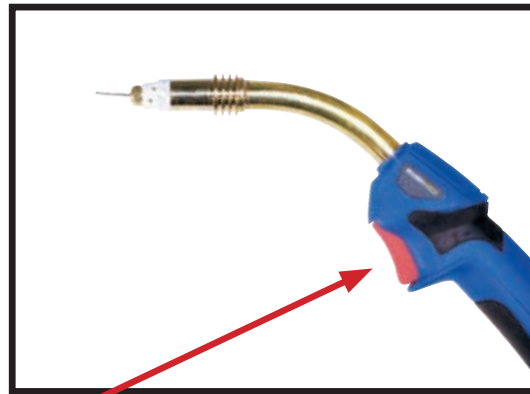

5 Press the trigger. This will feed the wire through the torch. Release button when wire appears at the end of the torch.

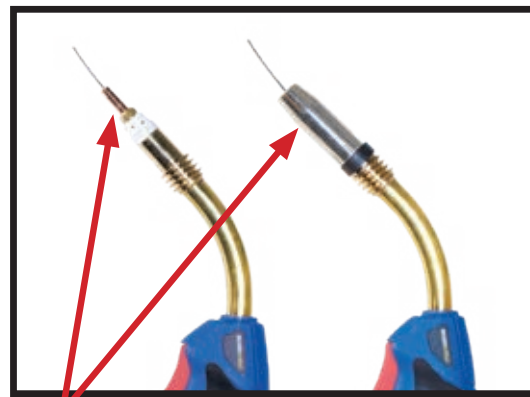

6 Re install tip over the wire and tighten using the tool supplied, Do NOT over tighten, or you may damage the tip holder and re-attach nozzle to torch.

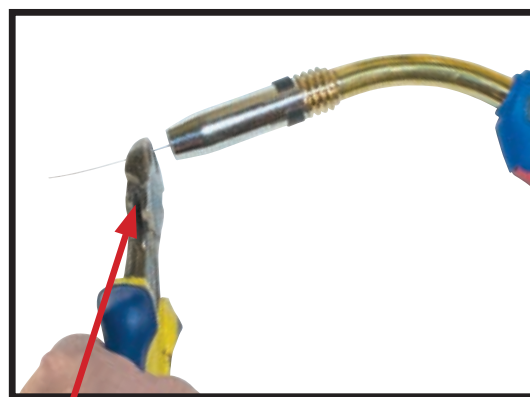

7 Trim wire to the end of the nozzle.

MIG TORCH LINER INSTALLATION / REPLACEMENT

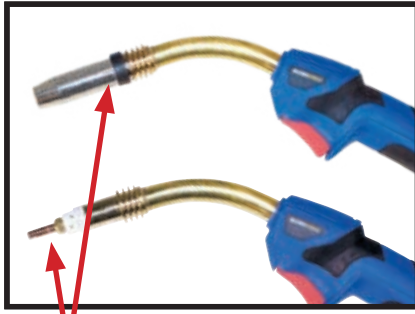

1 Lay the MIG torch out straight and flat on the ground and remove the front end parts

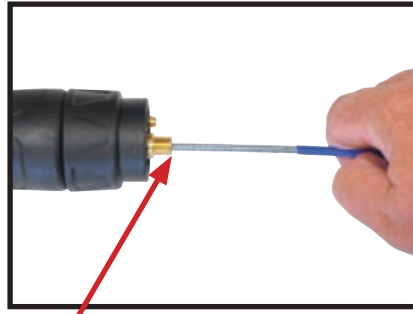

4 Carefully feed the new liner into the torch lead all the way out the end of the torch

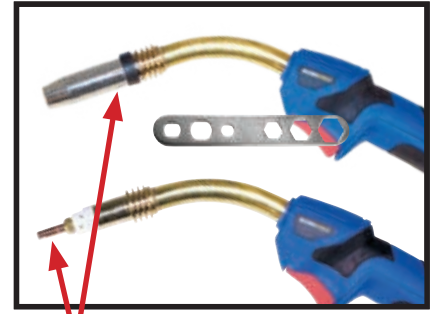

7 Re install tip and tighten using the tool provided and re attach nozzle to torch. Do NOT over tighten, or you may damage the tip holder



2 Remove the liner retaining nut from the euro torch end.

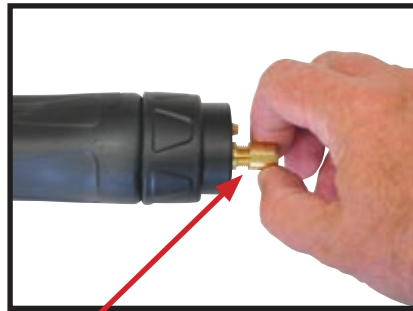

5 Fit the retaining nut and slightly tighten the nut about half way

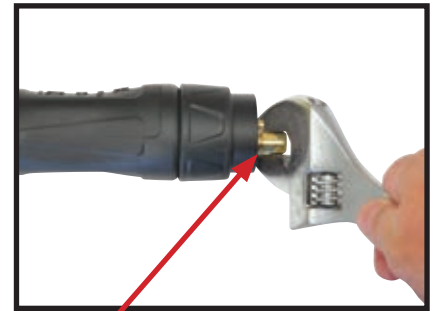

8 Tighten the retaining nut up all the way.

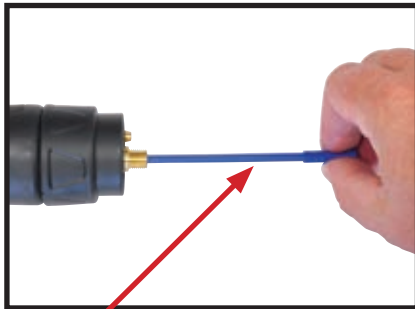

3 Carefully remove the liner completely from the torch.

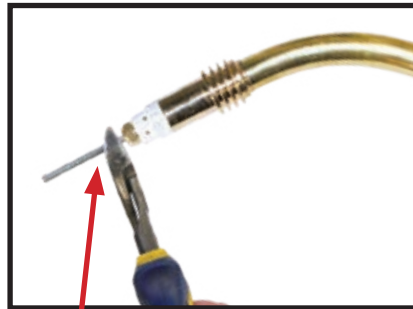

6 Snip the new liner 3mm past the end of the torch neck

Steel Liners



Teflon Liners for Aluminium



PART NO.	DESCRIPTION	ORIGINAL REF
92.04.B3	Blue steel liner 0.6 - 0.8mm 3mt	124.0011
92.04.B4	Blue steel liner 0.6 - 0.8mm 4mt	124.0012
92.04.B5	Blue steel liner 0.6 - 0.8mm 5mt	124.0015
92.04.R3	Red steel liner 0.9 - 1.2mm 3mt	124.0026
92.04.R4	Red steel liner 0.9 - 1.2mm 4mt	124.0031
92.04.R5	Red steel liner 0.9 - 1.2mm 5mt	124.0035
92.04.BT3	Blue teflon liner 0.6 - 0.9mm 3mt	126.0005
92.04.BT4	Blue teflon liner 0.6 - 0.9mm 4mt	126.0008
92.04.RT3	Red teflon liner 0.9 - 1.2mm 3mt	124.0011
92.04.RT4	Red teflon liner 0.9 - 1.2mm 4mt	124.0012
92.04.RT5	Red teflon liner 0.9 - 1.2mm 5mt	124.0015

Note: Pictures may vary from your machine model

MACHINE DRIVE ROLLER SIZE

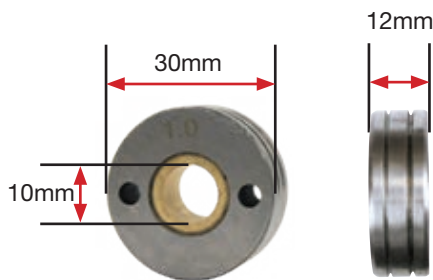

PART No:

DESCRIPTION

Knurled Drive Roller For Flux Cored Wire

RK301012.08.09	Drive Roller 0.8/0.9mm Knurled 30 x 10 x 12mm
RK301012.08.10	Drive Roller 0.8/1.0mm Knurled 30 x 10 x 12mm
RK301012.09.12	Drive Roller 0.9/1.2mm Knurled 30 x 10 x 12mm
RK301012.10.12	Drive Roller 1.0/1.2mm Knurled 30 x 10 x 12mm
RK301012.12.16	Drive Roller 1.2/1.6mm Knurled 30 x 10 x 12mm

U Grooved Drive Roller For Aluminium Wire

RU301012.08.09	Drive Roller 0.8/0.9mm U Groove 30 x 10 x 12mm
RU301012.08.12	Drive Roller 0.8/1.2mm U Groove 30 x 10 x 12mm
RU301012.10.12	Drive Roller 1.0/1.2mm U Groove 30 x 10 x 12mm
RU301012.12.16	Drive Roller 1.2/1.6mm U Groove 30 x 10 x 12mm

V Grooved Drive Roller For Solid Wire

RV301012.06.08	Drive Roller 0.6/0.8mm V Groove 30 x 10 x 12mm
RV301012.08.10	Drive Roller 0.8/1.0mm V Groove 30 x 10 x 12mm
RV301012.09.12	Drive Roller 0.9/1.2mm V Groove 30 x 10 x 12mm
RV301012.10.12	Drive Roller 1.0/1.2mm V Groove 30 x 10 x 12mm
RV301012.12.16	Drive Roller 1.2/1.6mm V Groove 30 x 10 x 12mm

2T / 4T TRIGGER CONTROL

2T Trigger Control

1. Press the trigger and Hold
2. The set pre-gas flow starts and the arc starts and will upslope to the amperage selected on the amperage dial.
3. When you want to finish the weld, release the trigger and the amperage will begin to downslope at the rate you have selected on the downslope dial, If you selected zero the arc will stop as soon as you release the trigger.

4T Trigger Control

1. Press the trigger and Hold
2. The set preflow gas starts and the arc starts.
3. Release the trigger and the amperage will upslope to the amperage selected on the amperage dial
4. When you want to finish the weld, press and hold the trigger and the amperage will begin to downslope at the rate you have selected on the downslope dial, amperage will remain at this level until you release the trigger.
5. Once you have released the trigger the arc will stop and the postflow gas will continue for a pre set amount of time

Proper MIG Torch inspection

Prior to welding, ensure all connections are tight and that consumables and equipment are in good condition and free from damage. Start with the front of the gun and work your way back to the feeder. A tight neck connection is essential to carry the electrical current from the welding cable to the front-end consumables. Also, be sure to visually inspect the handle and trigger to check there are no missing screws or damage. The cable should be free of cuts, kinks and damage along the outer cover. Cuts in the cable can expose the internal copper wiring and create a potential safety hazard to the welding operator. In addition, these issues can lead to electrical resistance that causes heat buildup — and ultimately cable failure.

Consumables

MIG gun front-end consumables are exposed to heat and spatter and therefore often require frequent replacement. However, performing some simple maintenance can help extend consumable life and improve gun performance and weld quality. The gas diffuser provides gas flow to the weld pool and also connects to the neck and carries the electrical current to the contact tip. Make sure all connections are tight, and check the diffuser's O-rings for cracks, cuts or damage. The nozzle's main role is to focus the shielding gas around the weld pool. Watch for spatter buildup in the nozzle, which can obstruct gas flow and lead to problems due to inadequate shielding coverage. Use MIG pliers to clean spatter from the nozzle. The contact tip is the last point of contact between the welding equipment and the welding wire. Keyholing of the contact tip is a concern to watch for with this consumable. This occurs when the wire passing through the tip wears an oblong-shaped slot into the diameter of the tip. Keyholing can put the wire out of center and cause problems such as an erratic arc. If you are experiencing wire feeding issues, try changing the contact tip or switching to a larger-size contact tip. Tips that look worn should be replaced.

Spatter removal from inside and outside the nozzle using MIG pliers

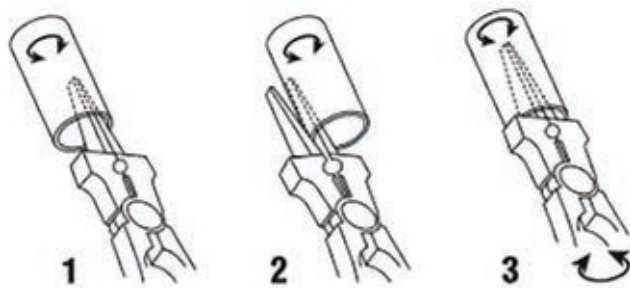

Build up of spatter can cause damage to nozzle and tip

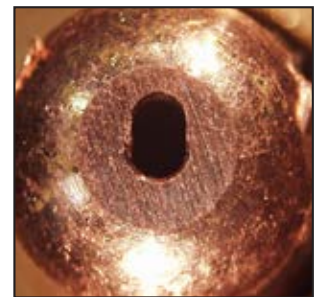

Keyholing of the contact tip

Final thoughts

Taking the time for preventative maintenance can pay off in less downtime in the long run. Along with that, always remember to properly store your MIG gun consumables to help you achieve the best results and extend the life of your equipment. When not in use, the MIG gun should be stored in a coiled position, either hanging or lying flat, such as on a shelf. Do not leave MIG gun on the floor of the shop, where there is a chance the cable could be run over, kinked or damaged.

WELDING PRODUCTS TO HELP PROLONG, MAINTAIN AND PRODUCE BETTER WELDS

Bossweld Aerosol Anti Spatter Spray

This silicon free spatter release coating is a colourless film which stops weld spatter from sticking to welding equipment, work pieces & fixtures. Easily removed before painting or finishing.

Bossweld Tip Dip Gel

Non toxic water based dipping gel for the prevention of weld spatter adherence to MIG torch parts. This silicon free compound is used to prolong the life of nozzles & tips.

Bossweld 8 Ways MIG Welding Pliers

Handy 8 function welders pliers. Functions include, nozzle removal, tip removal, cleaning inside of nozzle and wire cutting.



MACHINE SET UP STICK/MMA

Note: The below image shows setup for DCEP / Negative Polarity
(Most Common application)

6. Select Stick / MMA mode



2. Connect Electrode holder to the **+** terminal

3. Connect earth Clamp to the **-** terminal



1 Plug the machine 15Amp/3 Phase input power lead into the wall socket, ensuring that the power switch on the machine is in the OFF position.

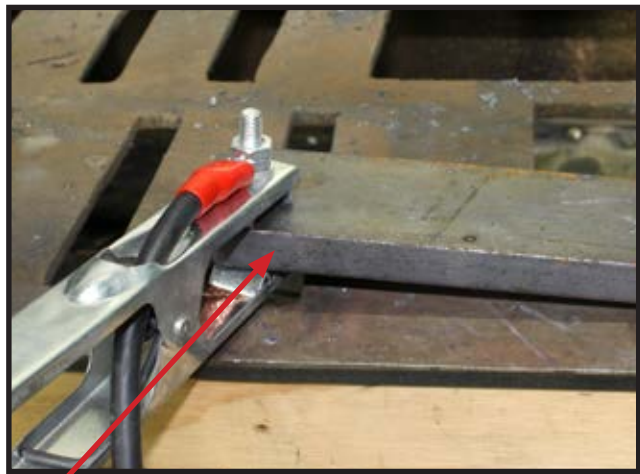

3 Connect earth clamp firmly to work-piece ensuring that the clamp makes good contact with bare metal.

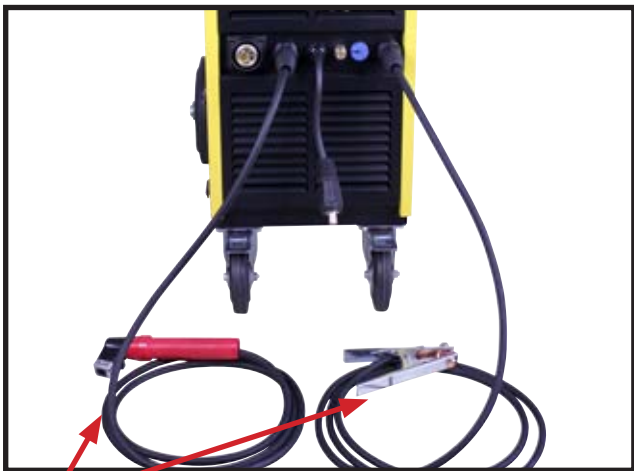

2 Assemble Arc and Earth leads into the welding terminals depending on requirements of electrodes. Refer to your electrode packet for polarity and current requirements.

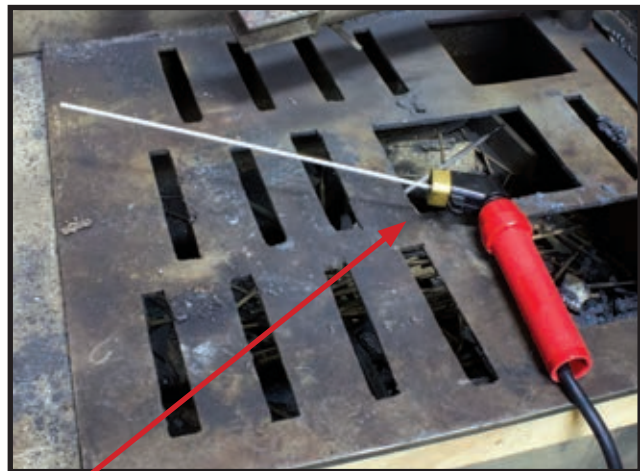

4 Take electrode holder and insert bare metal rod end of electrode and twist red handle to clamp electrode.

- DCEP/ Negative Polarity (most common application)
 - Earth clamp connector into the negative terminal.
 - Electrode holder connector into the positive terminal.
- DCEN/Straight Polarity
 - Earth clamp connector into the Positive terminal.
 - Electrode holder connector into the Negative terminal.

MACHINE SET UP STICK/MMA - CONTINUED



5 Ensure the electrode/electrode holder is not near the work-piece or can earth out, turn the machine on using the mains power switch. The front displays will light up and the cooling fan will start.



8 You can adjust the Arc force by using voltage Parameter adjustment knob.

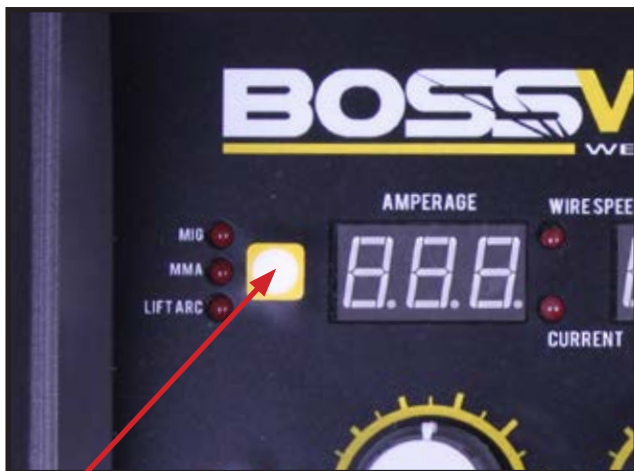

6 Select Stick / MMA on Welding Output Mode Switch.

Average Metal Thickness	Electrode Size
1.0 - 2.0mm	2.0mm
2.0 - 5.0mm	2.6mm
5.0 - 8mm	3.2mm
8.0mm +	4.0mm

Amperage Selection Guide	
Rod Size/ Gauge	Welding Current
1.6mm	40-50 Amps
2.0mm	50-75 Amps
2.5mm	75-105 Amps
3.2mm	105-140 Amps
4.0mm	140-160 Amps

9 Please see table on page 21 as a guide to Welding Parameters.



7 Select your required current by turning the Welding Parameter Adjustment Knob.

Note: Pictures may vary from your machine model

MANUAL METAL ARC PROCESS (MMA WELDING)

When an arc is struck between the metal rod (electrode) and the workpiece, both the rod and workpiece surface melt to form a weld pool. Simultaneous melting of the flux coating on the rod will form gas and slag which protects the weld pool from the surrounding atmosphere. The slag will solidify and cool and must be chipped off the weld bead once the weld run is complete (or before the next weld pass is deposited). The process allows only short lengths of weld to be produced before a new electrode needs to be inserted in the holder. Weld penetration is low and the quality of the weld deposit is highly dependent on the skill of the welder.

TYPES OF ELECTRODES

Arc stability, depth of penetration, metal deposition rate and positional capability are greatly influenced by the chemical composition of the flux coating on the electrode. There are many types of Electrodes, and these are generally matched to the base metal. For example if welding Mild Steel then select a Mild Steel (General Purpose Electrode). Electrodes are identified by a universal numbering system (AWS Type code).

Base Metal	Electrode Type	Type
Mild Steel	Mild Steel General Purpose	6013
Stainless Steel	Stainless Steel 316L	316L
Dissimilar Metals	Dissimilar 680	312
Cast Iron	Nickel Arc 98	Ni99
High Strength Steel	Low Hydrogen	TC16

Electrodes are often packed in sealed packaging to keep moisture out. However, if a pack has been opened or damaged, it is essential that the electrodes are redried according to the manufacturer's instructions.

ARC FORCE

Also called Dig and Arc Control. Gives a power source variable additional amperage during low voltage (short arc length) conditions while welding. Helps avoid "sticking" stick electrodes when a short arc length is used.

POWER SOURCE

Electrodes can be operated with AC and DC power supplies. Not all DC electrodes can be operated on AC power sources; however AC electrodes may be used on either AC or DC

ELECTRODE SIZE SELECTION

Electrode size selection will be determined by the thickness of the section being welded. A thicker section will need a larger diameter electrode. The table below shows the maximum size of electrodes for average thicknesses of section (based on General Purpose 6013 Electrode).

Average Metal Thickness	Electrode Size
1.0 - 2.0mm	2.0mm
2.0 - 5.0mm	2.6mm
5.0 - 8mm	3.2mm
8.0mm +	4.0mm

WELDING CURRENT

Welding current level is determined by the size of electrode - the normal operating range and current are recommended by manufacturers. Typical operating ranges for a selection of electrode sizes are illustrated in the table. As a rule of thumb when selecting a suitable current level, an electrode will require about 40 Amps per millimeter (diameter). Therefore, the preferred current level for a 4mm diameter electrode would be 160 Amps, but the acceptable operating range is 140 to 180 Amps. It is important to match the machine to the job

Amperage Selection Guide	
Rod Size/ Gauge	Welding Current
1.6mm	40-50 Amps
2.0mm	50-75 Amps
2.5mm	75-105 Amps
3.2mm	105-140 Amps
4.0mm	140-160 Amps

MACHINE SET UP GASLESS MIG WELDING

8. Select MIG mode



4. Connect MIG Torch to the Euro Connection terminal

NOTE: Ensure connector nut is tighten firmly

6. Connect earth Clamp to the (+) terminal

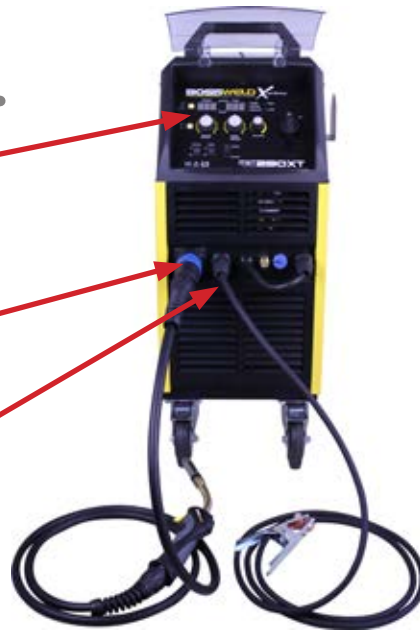

1 Plug the machine 15Amp/3 Phase input power lead into the wall socket, ensuring that the power switch on the machine is in the OFF position.

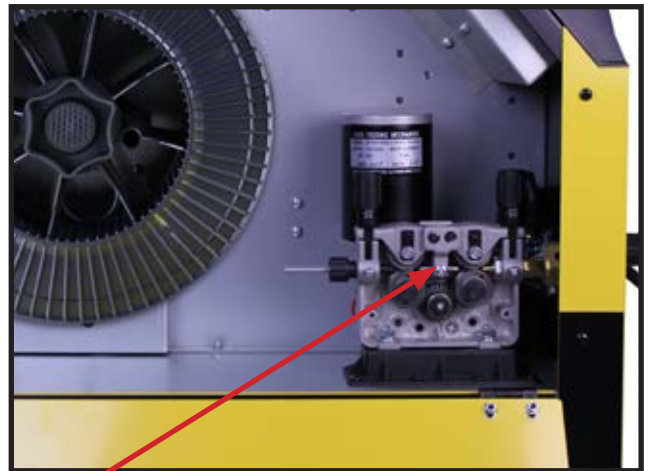

3 Set up the wire feed unit as per section "Set up Wire Feed Unit".

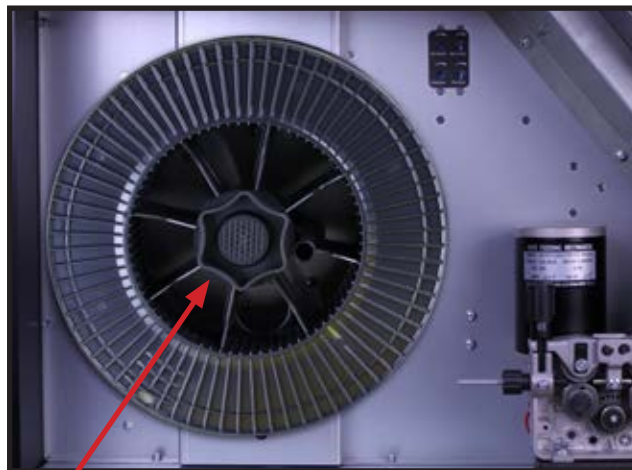

2 Open wire feed side panel and install Gasless wire into machine ensuring the drive roller is matched to the wire size and type. Refer to "Drive Feed Roller Selection" on Page 19
Note: Wire to roll from under spool into wire feeder

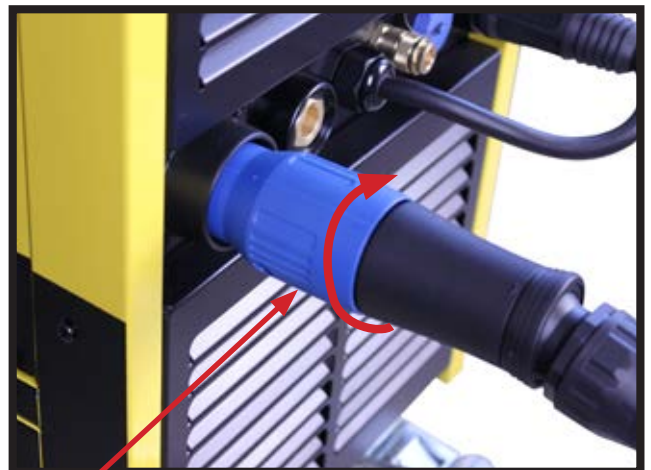
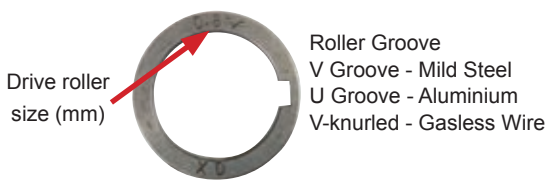

4 Install Euro connect MIG torch over the protruding wire, line up the spring connectors and screw the Euro connector nut up firmly.

Note: Pictures may vary from your machine model

MACHINE SET UP GASLESS MIG WELDING CONTINUED



5 Ensure the polarity is correct for gasless welding, DCEN

SETTING MACHINE POLARITY

DCEN - GASLESS		DCEP - GAS	
+	●	+	●
-	●	-	●

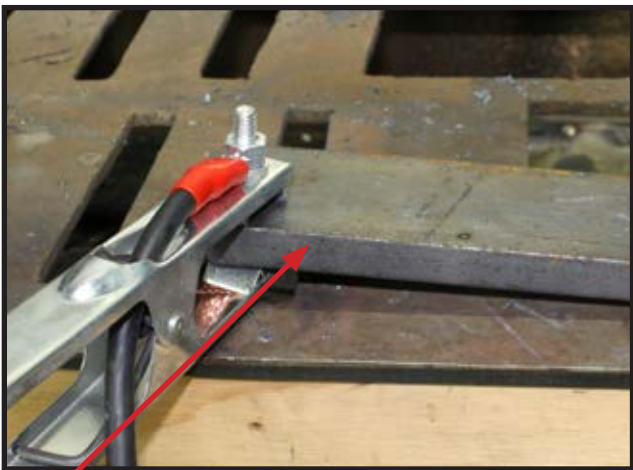

6 Fit the Earth lead Dinse Plug to the positive terminal for gasless welding and then connect earth clamp to the work piece ensuring that the clamp makes good contact with bare metal.



7 Switch the machine on using the mains power switch. Wait a few seconds whilst the machine powers up

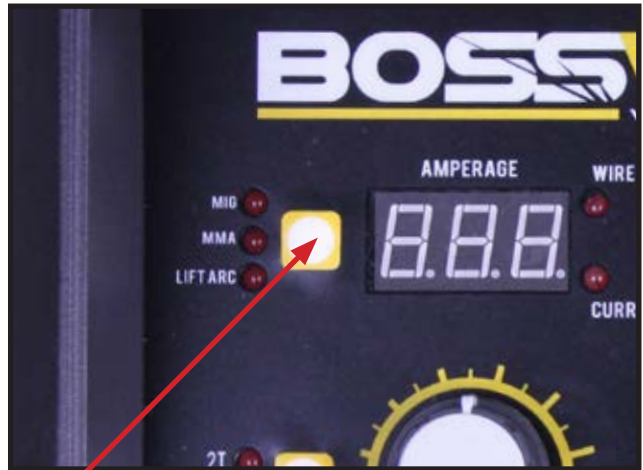

8 Press the Welding Mode Selection Button to select MIG.

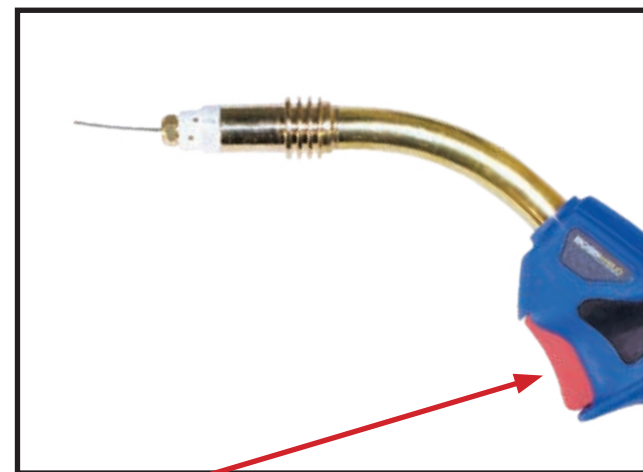

9 Remove nozzle and tip from torch and press trigger on the welding torch, this will feed the wire through the torch. Release button when wire appears at the end of the torch.

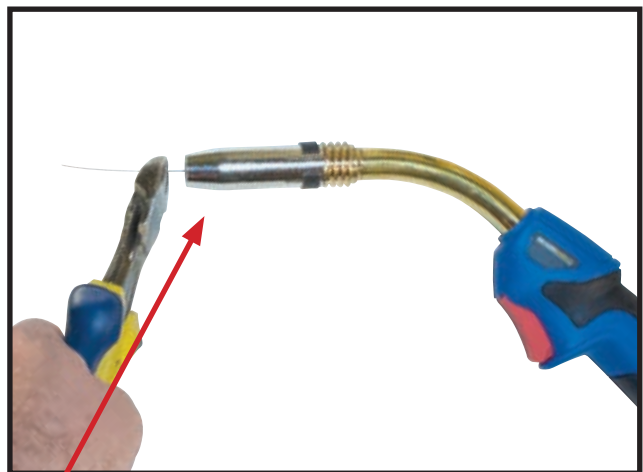

10 Re install tip and nozzle to torch and trim wire to the end of the nozzle.

Note: Pictures may vary from your machine model

MACHINE SET UP GASLESS MIG WELDING CONTINUED



11 It is recommended for ease of use that the wire-feed target speed is adjusted first and then the voltage setting fine-tuned if necessary. To adjust wire speed, turn Welding parameter Adjustment Knob. Ref MIG Welding Setting Guide on page 33-34



12 To adjust welding voltage, turn Welding parameter Adjustment Knob. Ref MIG Welding Setting Guide on page 33-34
Note: It is advisable to run a few test welds using scrap or offcut materials, in order to tune the machine to the correct settings prior to welding the job.

MACHINE SET UP GAS MIG WELDING



13 & 14. Fit gas regulator to bottle and install gas hose to the inlet on the back panel of welder. Turn on regulator and set gas flow to between 10-15 L/min depending on your welding environment.

8. Select MIG mode

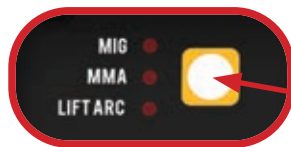

4. Connect MIG Torch to the Euro Connection terminal

NOTE: Ensure connector nut is tighten firmly



6. Connect earth Clamp to the  terminal

IMPORTANT! - We strongly recommend that you check for gas leakage prior to operation of your machine. We recommend that you close the cylinder valve when the machine is not in use. BOSSWELD authorised representatives or agents of BOSSWELD will not be liable or responsible for the loss of any gas.

Note: Pictures may vary from your machine model



1 Plug the machine 15Amp/3 Phase input power lead into the wall socket, ensuring that the power switch on the machine is in the OFF position.

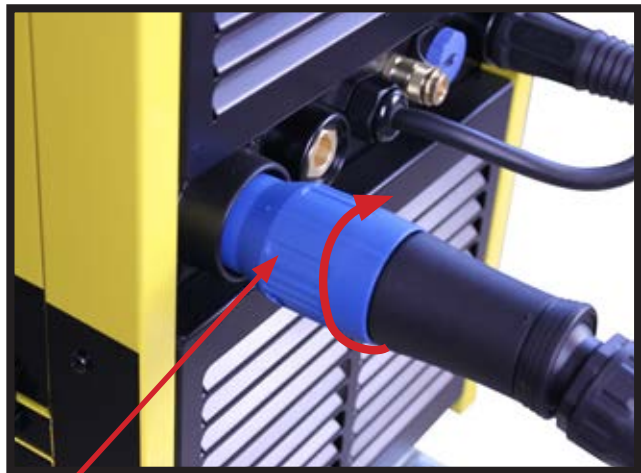

4 Install Euro connect MIG torch over the protruding wire, line up the spring connectors and screw the Euro connector nut up firmly.

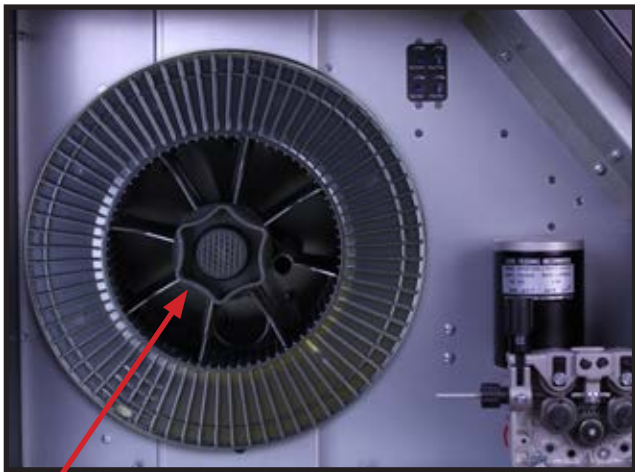

2 Open wire feed side panel and install wire into machine ensuring the drive roller is matched to the wire size and type. Refer to "Drive Feed Roller Selection" on Page 19 Note: Wire to roll from under spool into wire feeder



5 Ensure the polarity is correct for gas welding, DCEP



Drive roller size (mm)

Roller Groove
V Groove - Mild Steel
U Groove - Aluminium
V-knurled - Gasless Wire

SETTING MACHINE POLARITY

DCEN - GASLESS	DCEP - GAS

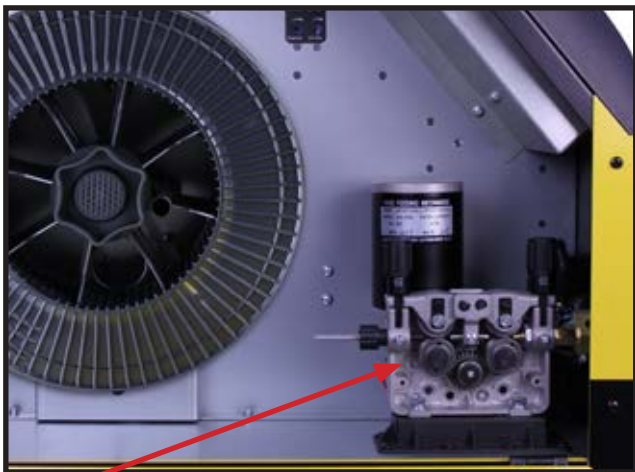

3 Set up the wire feed unit as per section "Set up Wire Feed Unit".

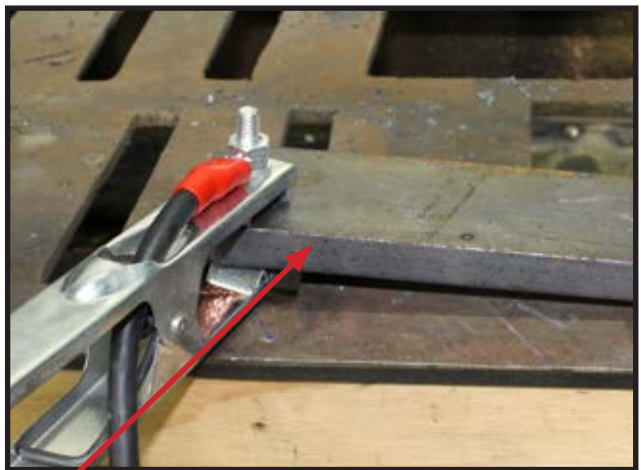

6 Fit the Earth lead Dinse Plug to the negative terminal for gas welding and then connect earth clamp to the work piece ensuring that the clamp makes good contact with bare metal.

Note: Pictures may vary from your machine model

MACHINE SET UP GAS MIG WELDING CONTINUED



7 Switch the machine on using the mains power switch. Wait a few seconds whilst the machine powers up

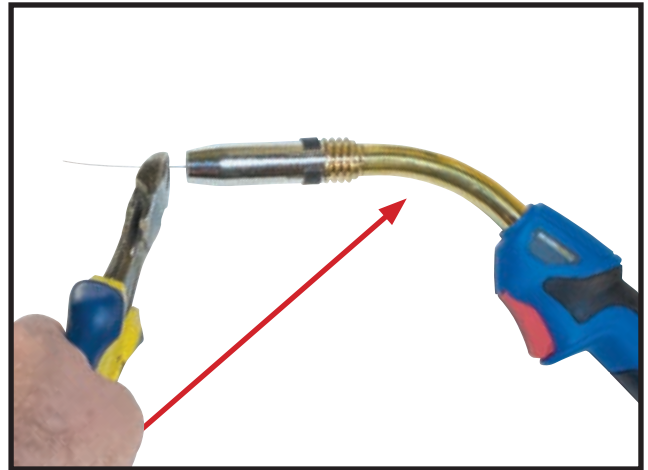

10 Re install tip and nozzle to torch and trim wire to the end of the nozzle. The multifunction digital display will show two numbers. On the left is the wire speed, on the right is welding voltage. These values are adjusted by rotating the Welding Parameter Adjustment Knobs below them.

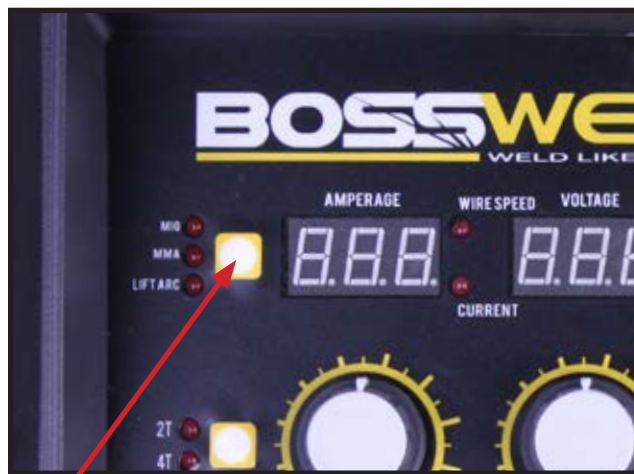

8 Press the Welding Mode Selection Button until the MIG indicator is lit.



11 It is recommended for ease of use that the wire-feed target speed is adjusted first and then the voltage setting fine-tuned if necessary. To adjust wire speed, turn Welding parameter Adjustment Knob. Ref MIG Welding Setting Guide on page 33-34

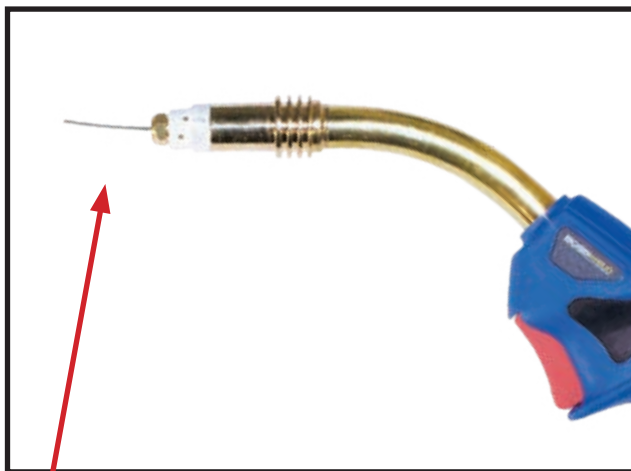

9 Remove nozzle and tip from torch and press trigger on the welding torch, this will feed the wire through the torch. Release button when wire appears at the end of the torch.



12 To adjust welding voltage, turn Welding parameter Adjustment Knob. Ref MIG Welding Setting Guide on page 33-34

Note: Pictures may vary from your machine model

MACHINE SET UP GAS MIG WELDING CONTINUED



- 13 Fit gas regulator to the gas bottle and install gas hose to the gas inlet on the back panel of welder.

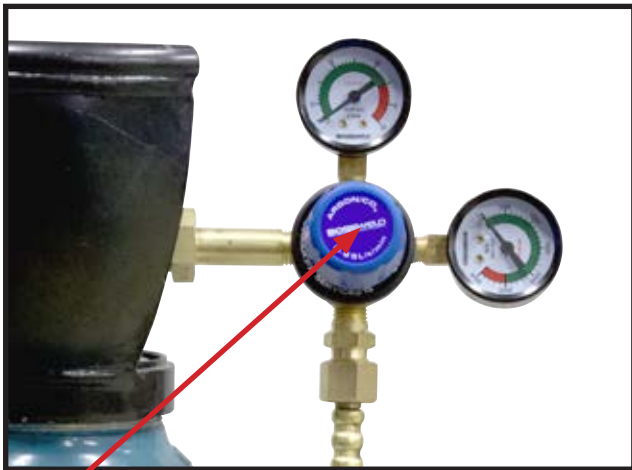

- 14 Turn on regulator and set gas flow to between 10-15 L/min depending on your welding environment.

Note:

It is advisable to run a few test welds using scrap or offcut materials, in order to tune the machine to the correct settings prior to welding the job.

IMPORTANT! - We strongly recommend that you check for gas leakage prior to operation of your machine. We recommend that you close the cylinder valve when the machine is not in use. BOSSWELD authorised representatives or agents of BOSSWELD will not be liable or responsible for the loss of any gas.

NOTE: SPOOL GUN IS NOT SUPPLIED WITH MACHINE - SEE PAGE 43 FOR TORCH OPTIONS

MACHINE SET UP SPOOL GUN WELDING

11. Select MIG mode

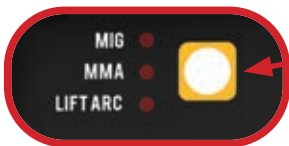

2. Connect Spool Gun to the Euro Connection terminal

NOTE: Ensure connector nut is tighten firmly

14. Connect earth Clamp to the terminal



17 & 18. Fit gas regulator to bottle and install gas hose to the inlet on the back panel of welder. Turn on regulator and set gas flow to between 10-15 L/ min depending on your welding environment.



1 Plug the machine 15Amp/3 Phase input power lead into the wall socket, ensuring that the power switch on the machine is in the OFF position.



3 Open wire cover panel by loosening the retaining nut and removing the cover



2 Install the Spool Gun to the machine by connecting Euro Connector and the Control Socket and screw the nut up firmly. Connect the earth clamp to negative the dinse connector. Push gas hose in to quick connect.

Ensure the polarity is correct for gas welding, DCEP

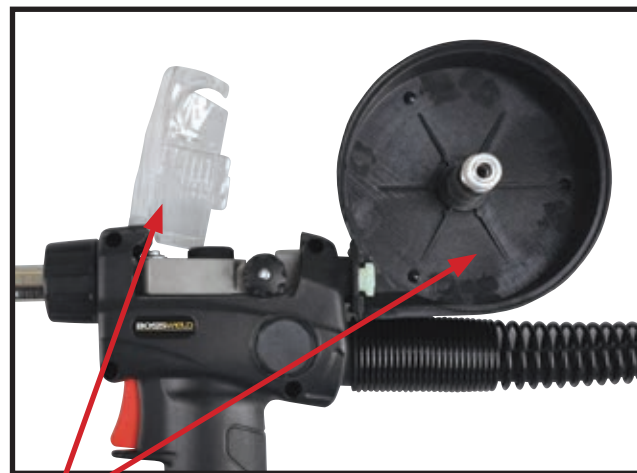

4 Remove the spool cover and lift wire drive cover

SETTING MACHINE POLARITY

DCEN - GASLESS	DCEP - GAS

Note: Pictures may vary from your machine model

MACHINE SET UP SPOOL GUN WELDING CONTINUED

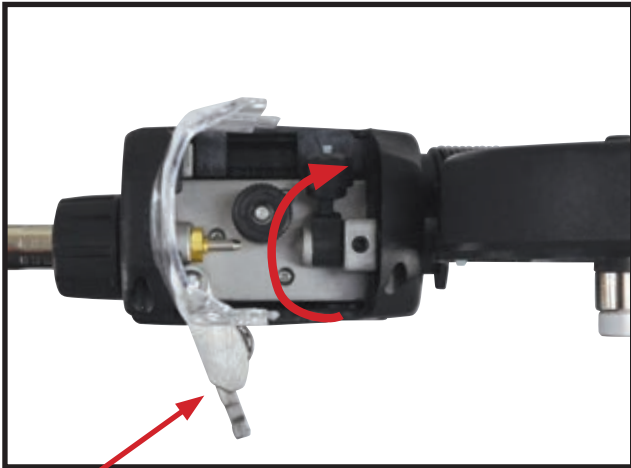

- 5 Release the wire tensioning arm, and check the correct drive roller size matches the wire being used



- 8 Replace the spool cover and close the wire drive cover



- 6 Feed the wire over the drive roller and into the inlet guide, make sure you hold the spool to stop it unraveling.



- 9 Turn the spool gun switch on the machine control panel to ON

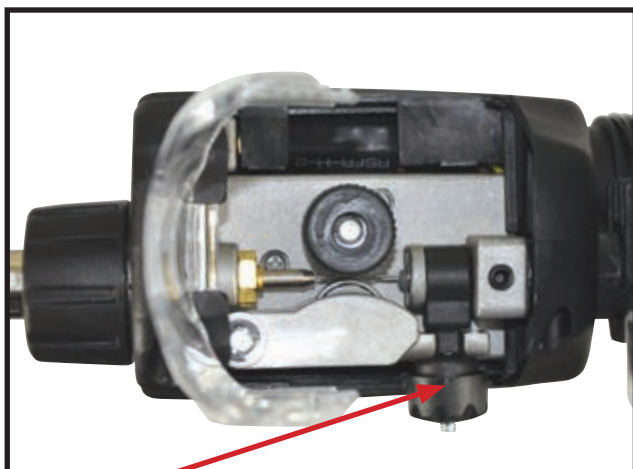

- 7 Re-latch the tensioning arm, making sure you still hold the spool to stop it unraveling. Screw in to increase tension.



- 10 Switch the machine on using the mains power switch. Wait a few seconds whilst the machine powers up

Note: Pictures may vary from your machine model

MACHINE SET UP SPOOL GUN WELDING CONTINUED

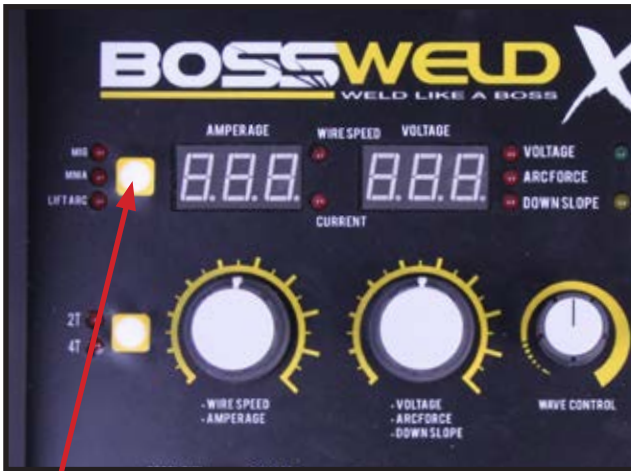

11 Press the Welding Mode Selection Button to select MIG.

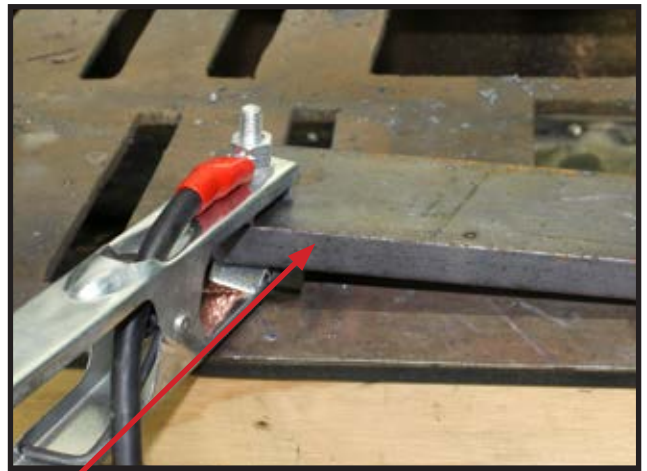

14 Connect earth clamp to the work piece ensuring that the clamp makes good contact with bare metal.

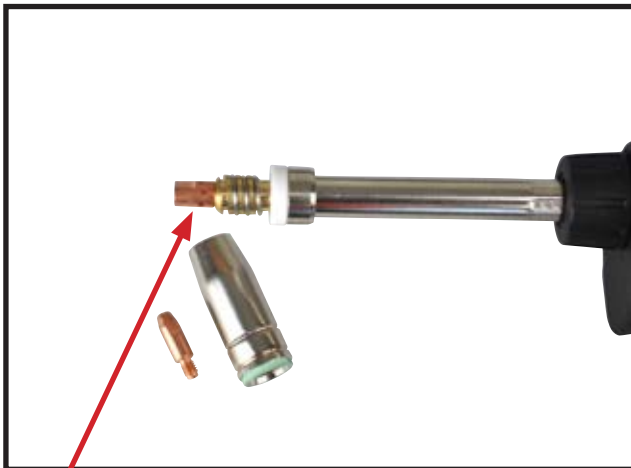

12 Remove nozzle and tip from torch and press trigger on the torch, this will feed the wire through the torch. Release trigger when wire appears at the end of the torch.



15 It is recommended for ease of use that the wire-feed target speed is adjusted first and then the voltage setting fine-tuned if necessary. To adjust wire speed, turn Welding parameter Adjustment Knob. Ref MIG Welding Setting Guide on page 33-34

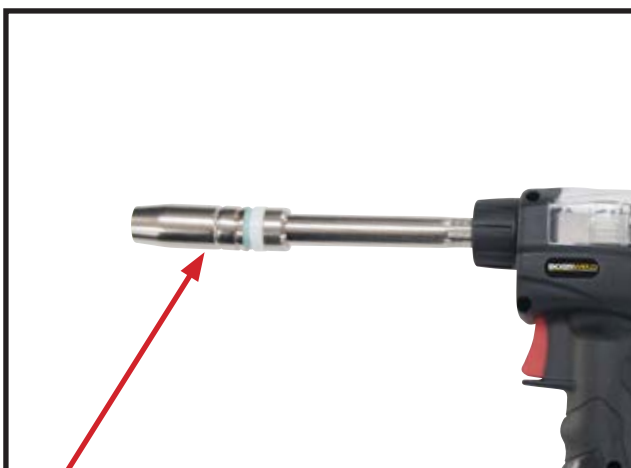

13 Re install tip and nozzle to torch and trim wire to the end of the nozzle.



16 To adjust welding voltage, turn Welding parameter Adjustment Knob. Ref MIG Welding Setting Guide on page 33-34

Note: Pictures may vary from your machine model

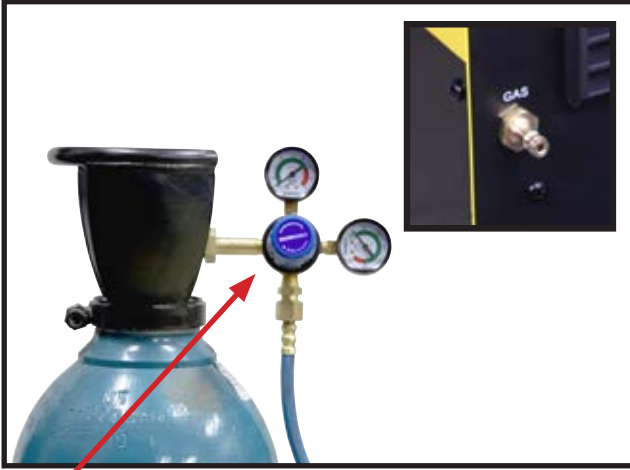

- 17 Fit gas regulator to the gas bottle and install gas hose to the gas inlet on the back panel of welder.

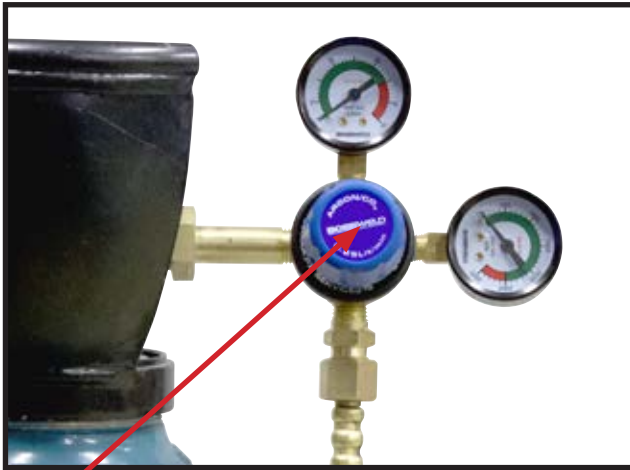

- 18 Turn on regulator and set gas flow to between 10-15 L/min depending on your welding environment.

Note:

It is advisable to run a few test welds using scrap or offcut materials, in order to tune the machine to the correct settings prior to welding the job.

IMPORTANT! - We strongly recommend that you check for gas leakage prior to operation of your machine. We recommend that you close the cylinder valve when the machine is not in use. BOSSWELD authorised representatives or agents of BOSSWELD will not be liable or responsible for the loss of any gas.

BASIC MIG WELDING GUIDE

The welding power supply has two control settings that have to balance. These are voltage control switches and the wire speed control. The welding amperage is determined by the voltage settings, the wire diameter, gas selection and the wire feed speed. The amperage will increase with higher voltage selection on the machine and higher wire feed speed. This is typically used for welding thick sections of steel. When welding thin sections of steel, a lower voltage selection and lower wire feed speed is required.

- When changing to a different wire diameter different control settings are required. A thinner wire needs more wire speed to achieve the same current level.
- A satisfactory weld cannot be obtained if the wire speed and voltage switch settings are not adjusted to suit the wire diameter and thickness of the material being welded.
- If the wire speed is too high for the welding voltage, “stubby” will occur as the wire dips into the molten pool. If the wire speed is too slow for the welding voltage, large drops will form on the end of the electrode wire, causing spatter. Suppose that wire speed is constant, if the welding voltage is too high, large drops will form on the end of the electrode wire, causing spatter; if the voltage is too low, the wire will not melt.

POSITION OF MIG GUN

The angle of MIG gun to the weld has an effect on the width of the weld run.

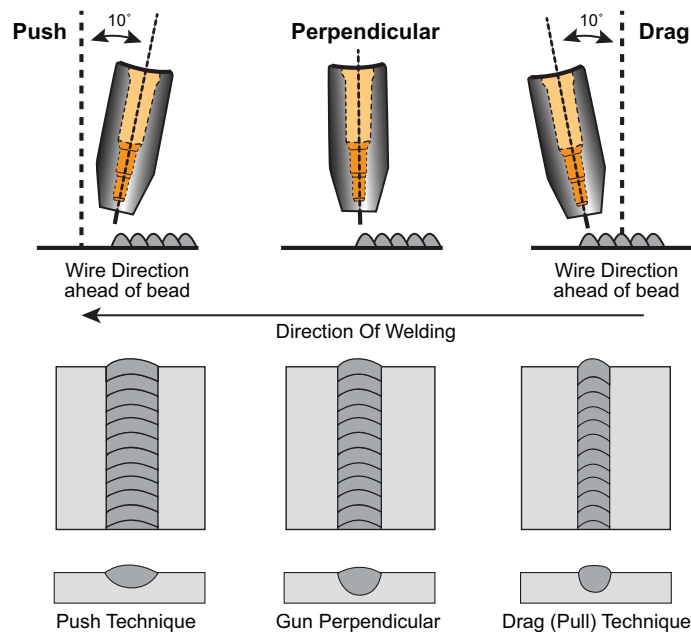

Distance from the MIG Gun Nozzle to the Work Piece

The electrode stick out from the MIG gun nozzle should be between 2.0mm to 5.0mm when welding with gas shielded wire. An increased distance of 5mm to 10mm is required when welding with Gasless wire. This distance will vary depending on the type of joint that is being weld. .

Travel Speed

Speed at which a weld travels influences the width of the weld and penetration of the welding run. Welding thin steel will have a faster travel speed than welding thick steel.

Wire Size Selection

The choice of wire size in conjunction with shielding gas used depends on:

- Thickness of the metal to be welded.
- Type of joint configuration
- Capacity of the wire feed unit and power supply.
- The amount of penetration required.
- The deposition rate required.
- The bead profile desired
- The position of welding and cost of the wire.
- Location of welding

		Carbon Steel						
		Mig Wire, Gas Shielded				Gasless, Flux Core Wire		
		0.6mm	0.8mm	0.9mm	1.2mm	0.8mm	0.9mm	1.2mm
MATERIAL THICKNESS	0.8	30-45						
	1.0	45-60	50-60					
	1.2	60-75	70-80			50-65		
	1.6	70-105	90-110	90-110		70-90	75-90	
	2.0		120-130	120-130		90-105	95-120	
	3.0		135-150	135-150		110-135	120-135	
	4.0		145-160	160-190		135-150	135-160	135-160
	6.0			175-210	190-220		145-165	150-170
	8.0			215-230	225-235		150-175	160-190
	10.0			220-240	230-250			200-230
	12.0			240+	250+			240+
Gas	Argon/Co2 - Co2				NO GAS			
		Stainless Steel			Aluminium			
		Mig Wire, Gas Shielded			Mig Wire, Gas Shielded			
		0.8mm	0.9mm	1.2mm	0.8mm	0.9mm	1.0mm	1.2mm
MATERIAL THICKNESS	0.8							
	1.0	40-50						
	1.2	50-60			50-70			
	1.6	65-80			75-95	90-110		
	2.0	75-90			85-105	90-115		
	3.0	95-120	125-135		110-130	110-135	120-140	
	4.0	140-155	145-155			135-150	140-160	145-170
	6.0		175-190			150-175	155-180	165-190
	8.0		200-210	220-250			185-220	190-230
	10.0		220-240	240-265				220-250
	12.0		235+	250+				250+
Gas	Argon/o2 - Argon/Co2			Argon				

Note:

1. The above amperage range is to be used as a guide only
2. Welding travel speed will affect the end weld result
3. For additional information on gas selection, consult your distributor

MIG WELDING SETTING GUIDES

Welding current	Welding Volt	Wave control	Wire Speed		
			(Wire Size)	0.6mm	0.8mm
40A	13~15V	1-2	2--3		
60A	14~16V	2-4	3--5	2--3	
80A	15~17V	3-5	6--8	3--5	2--3
100A	16~19V	3-5	8--10	3--6	3-5
120A	17~20V	4-6		4--7	3--5
140A	19~21V	5-10		5--8	3--5
160A	20~22V	5-10		6--9	4--7
180A	21~23V	5-10			6--9

GMAW (MIG) WELDING

Metal inert gas (MIG) welding is an attractive alternative to MMA (stick welding), offering high deposition rates and high productivity.

PROCESS CHARACTERISTICS

MIG welding is a versatile technique suitable for both thin sheet and thick section components. An arc is struck between the end of a wire electrode and the workpiece, melting both of them to form a weld pool. The wire serves as both heat source (via the arc at the wire tip) and filler metal for the joint. The wire is fed through a copper contact tube (contact tip) which conducts welding current into the wire. The weld pool is protected from the surrounding atmosphere by a shielding gas fed through a nozzle surrounding the wire. Shielding gas selection depends on the material being welded and the application. The wire is fed from a reel by a motor drive, and the welder moves the welding torch along the joint line. Wires may be solid (simple drawn wires), or cored (composites formed from a metal sheath with a powdered flux or metal filling).

Consumables are generally competitively priced compared with those for other processes. The process offers high productivity, as the wire is continuously fed.

Manual MIG welding is often referred to as a semi-automatic process, as the wire feed rate and arc length are controlled by the power source, but the travel speed and wire position are under manual control. The process can also be mechanised when all the process parameters are not directly controlled by a welder, but might still require manual adjustment during welding. When no manual intervention is needed during welding, the process can be referred to as automatic. The process usually operates with the wire positively charged and connected to a power source delivering a constant voltage. Selection of wire diameter (usually between 0.6 and 1.6mm) and wire feed speed determine the welding current, as the burn-off rate of the wire will form an equilibrium with the feed speed.

GMAW (MIG) WELDING CONTINUED

SHIELDING GAS

In addition to general shielding of the arc and the weld pool, the shielding gas performs a number of important functions:



- Forms the arc plasma
- Stabilizes the arc roots on the material surface
- Ensures smooth transfer of molten droplets from the wire to the weld pool

The shielding gas will have a substantial effect on the stability of the arc and metal transfer and the behaviour of the weld pool, in particular, its penetration. General purpose shielding gases for MIG welding are mixtures of argon, oxygen and CO₂, and special gas mixtures may contain helium.

The gases which are normally used for the various materials are:

- Steels: CO₂, argon +2 to 5% oxygen, argon +5 to 25% CO₂.
- Non-ferrous (e.g. Aluminium, copper or nickel alloys): Argon, argon / helium.

Argon based gases, compared with CO₂, are generally more tolerant to parameter settings and generate lower spatter levels with the dip transfer mode. However, there is a greater risk of lack of fusion defects because these gases are colder. As CO₂ cannot be used in the open arc (pulsed or spray transfer) modes due to high back-plasma forces, argon based gases containing oxygen or CO₂ are normally employed.

WELDING GAS SELECTION CHART GUIDE		
 MIG MIG WELDING	 ARGON	 Ar-CO₂-O₂
	MILD STEEL	X
STAINLESS STEEL	X	✓
LOW ALLOY STEEL	X	✓
GALVANISED STEEL	X	✓
ALUMINIUM	✓	X

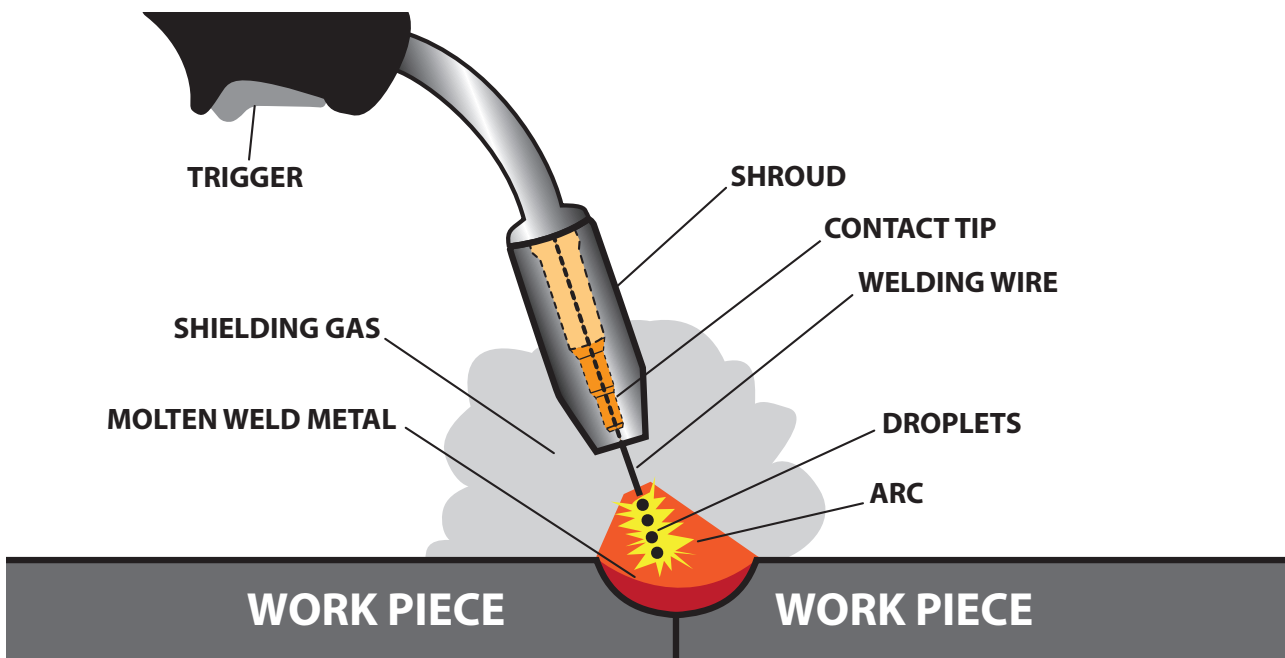

NOTE: TIG TORCH IS NOT SUPPLIED WITH MACHINE - SEE PAGE 42 FOR TORCH OPTIONS

MACHINE SET UP DC TIG WELD

4. Connect the Argon Gas Regulator supplied to the Gas bottle and connect the Gas Hose to the Gas Input socket on the rear of machine and the Regulator. Ensure the Gas regulator is in the off position.



2. Connect the Gas hose to the Gas Output and the TIG Torch Control Socket and screw the nut up firmly.

7. Select TIG mode



5. Connect earth Clamp to the (+) terminal

2. Connect TIG Torch to the (-) terminal

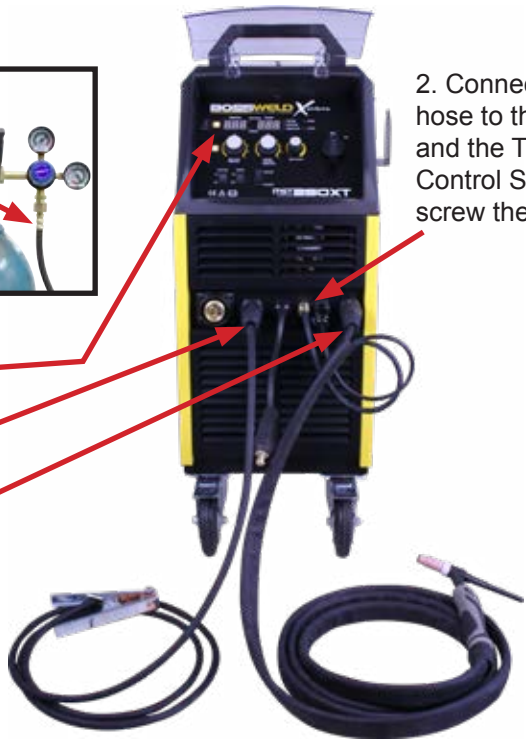

IMPORTANT! -

We strongly recommend that you check for gas leakage prior to operation of your machine. We recommend that you close the cylinder valve when the machine is not in use. BOSSWELD authorised representatives or agents of BOSSWELD will not be liable or responsible for the loss of any gas.

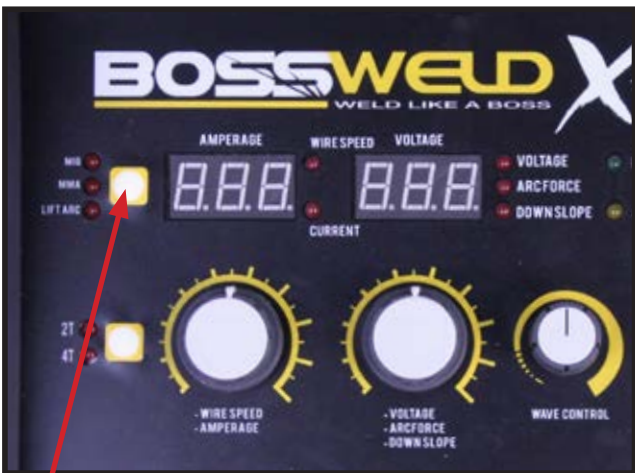

1 Plug the machine 15Amp/3 Phase input power plug into the wall socket, ensuring that the power switch on the machine is in the OFF position.

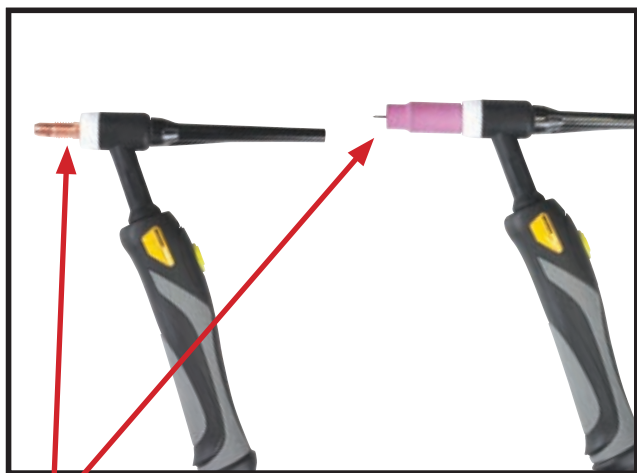

3 Set up the TIG torch. Place the Tungsten Electrode into the torch head and ensure back cap and collet body are screwed in firmly.



2 Install the TIG Torch to the machine by connecting the Dinse Connector to the Negative Output Connection Socket, the Gas hose to the Gas Output and the TIG Torch Control Socket and screw the nut up firmly.

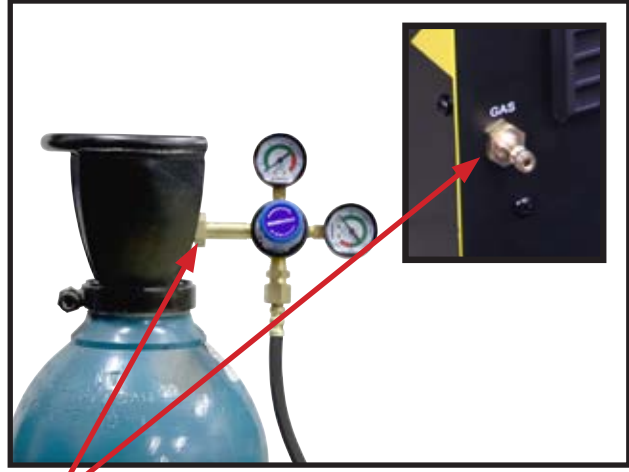

4 Connect the Argon Gas Regulator supply to the Gas bottle and connect the Gas Hose to the Gas Input socket on the rear of machine and the Regulator. Ensure the Gas regulator is in the off position.

MACHINE SET UP DC TIG WELD - CONTINUED

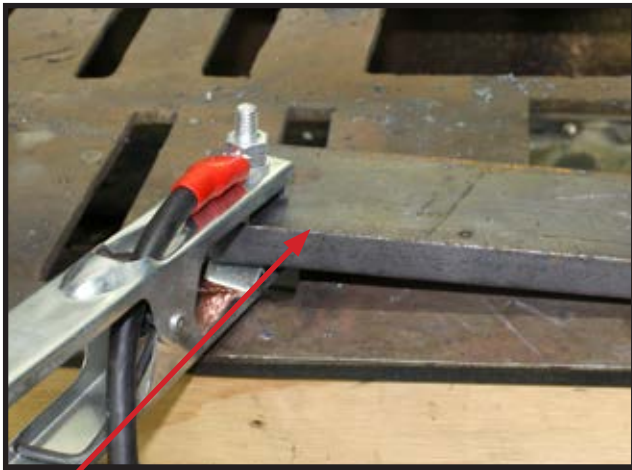

- 5 Fit the Earth lead Dinse Plug to the positive terminal for gasless welding and then connect earth clamp to the work piece ensuring that the clamp makes good contact with bare metal.



- 8 To adjust the Welding Current rotate the knob to the desired Amperage.



- 6 Switch the machine on using the mains power switch. Wait a few seconds whilst the machine powers up



- 9 You can also adjust the Down slope by adjusting the knob to the desired setting



- 7 Press the Welding Mode Selection Button until the TIG indicator is lit.



- 10 Turn on regulator and set gas flow to between 10-15 L/min depending on your welding environment.

Note: It is advisable to run a few test welds using scrap or offcut materials, in order to tune the machine to the correct settings prior to welding the job.

OPTIONAL REMOTE CURRENT & FOOT CONTROL REMOTE CURRENT SET UP



Note: Current Control TIG Torch sold separately. Visit www.bossweld.com.au for more information



Note: Foot Controller sold separately. Visit www.bossweld.com.au for more information



1 Set up TIG torch as per "MACHINE SET UP DC TIG WELD". Refer to pages 38-39.



1 Set up TIG torch as per "MACHINE SET UP DC TIG WELD". Refer to pages 38-39.



2 Turn the REMOTE switch on the machine control panel to ON



2 Plug Foot Controller into Remote Controller Plug on front panel and screw the nut firmly

Note: For TIG torches WITHOUT Current Control, Remote Switch MUST be set to OFF



3 Turn the REMOTE switch on the machine control panel to ON

TUNGSTEN PREPARATION & GRINDING

Caution: Grinding can create a hazard as the exposed tungsten/thoria area is greatly increased and fine particles of dust are released into the atmosphere. It is recommended that a dedicated grindstone with local dust extraction is used, and a simple filter mask is worn. If the grinding wheel is not fitted with a protective viewing screen, eye protection must be worn.

CORRECT PREPERATION - STABLE ARC

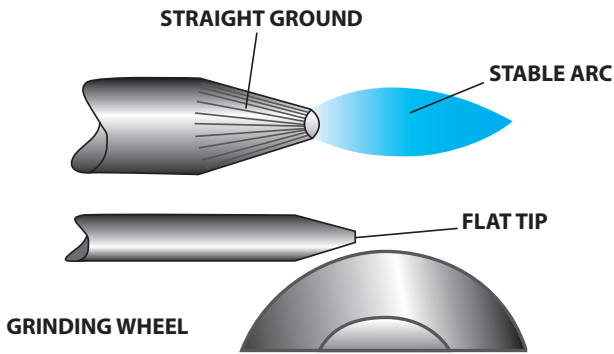

INCORRECT PREPERATION - STABLE ARC

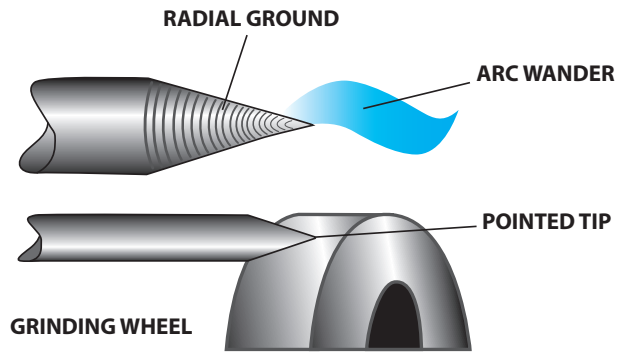

Note: Do not use wheel for other jobs or tungsten can become contaminated and cause lower weld quality

TIG WELDING

PROCESS CHARACTERISTICS

In the TIG process the arc is formed between a pointed tungsten electrode and the workpiece in an inert atmosphere of argon or helium. The small intense arc provided by the pointed electrode is ideal for high quality and precision welding. Because the electrode is not consumed during welding, the welder does not have to balance the heat input from the arc as the metal is deposited from the melting electrode. When filler metal is required, it must be added separately to the weldpool.

POWER SOURCE



TIG must be operated with a constant current power source. A constant current power source is essential to avoid excessively high currents being drawn when the electrode is short-circuited onto the workpiece surface. This could happen either deliberately during arc starting or inadvertently during welding. If, as in MIG welding, a flat characteristic power source is used, any contact with the workpiece surface would damage the electrode tip or fuse the electrode to the workpiece surface. In DC, because arc heat is distributed approximately one-third at the cathode (negative) and two-thirds at the anode (positive), the electrode is always negative polarity to prevent overheating and melting. However, the alternative power source connection of DC electrode positive polarity has the advantage in that when the cathode is on the workpiece, the surface is cleaned of oxide contamination.

ARC STARTING

The welding arc can be started by scratching the surface, forming a short-circuit. It is only when the short-circuit is broken that the main welding current will flow. However, there is a risk that the electrode may stick to the surface and cause a tungsten inclusion in the weld.

TIG WELDING - CONTINUED

This risk can be minimised using the 'lift arc' technique where the short-circuit is formed at a very low current level.

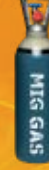
WELDING GAS SELECTION CHART GUIDE				
 TIG TIG WELDING	 ARGON		 Ar-CO₂-O₂	
	MILD STEEL	✓		✗
STAINLESS STEEL	✓		✗	
LOW ALLOY STEEL	✓		✗	

APPLICATIONS

TIG is applied in all industrial sectors but is especially suitable for high quality welding. In manual welding, the relatively small arc is ideal for thin sheet material or controlled penetration (in the root run of pipe welds). Because deposition rate can be quite low (using a separate filler rod) MMA or MIG may be preferable for thicker material and for fill passes in thick-wall pipe welds.

TIG is also widely applied in mechanised systems either autogenously or with filler wire. However, several 'off the shelf' systems are available for orbital welding of pipes, used in the manufacture of chemical plant or boilers. The systems require no manipulative skill, but the operator must be well trained. Because the welder has less control over arc and weldpool behaviour, careful attention must be paid to edge preparation (machined rather than hand-prepared), joint fit-up and control of welding parameters.

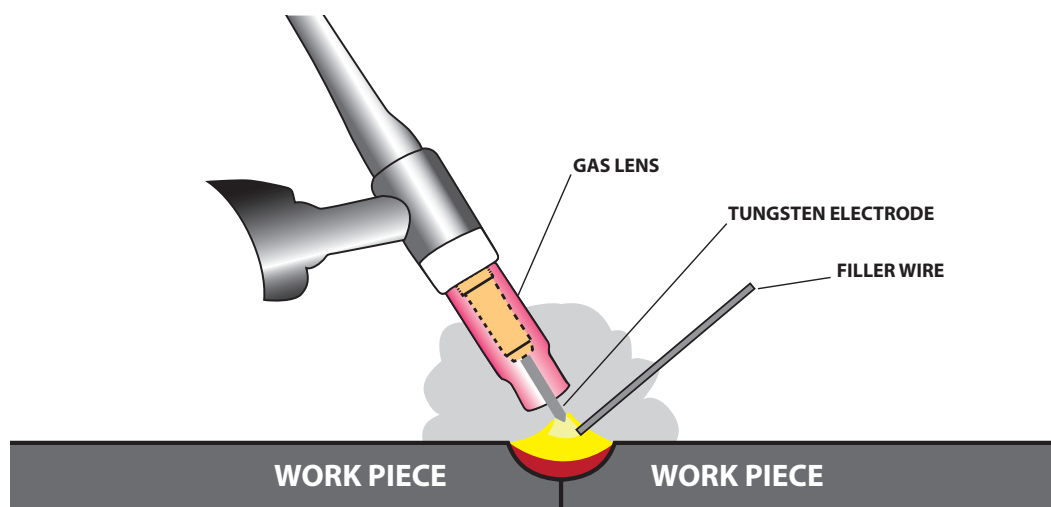

BOSSWELD BINZEL STYLE 24 MIG TORCH COMPLETE

PART NO.	DESCRIPTION
92.ER.24.3	BZ Style 24 MIG Torch 3m
92.ER.24.4	BZ Style 24 MIG Torch 4m
92.ER.24.5	BZ Style 24 MIG Torch 5m



BOSSWELD BINZEL STYLE 24 MIG TORCH SPARE PARTS



PART NO.	DESCRIPTION	ORIGINAL REF
92.02.24.CO	Adjustable conical nozzle ϕ 12.5 STD	145.0075
92.02.24.CL	Adjustable cylindrical ϕ 17mm	145.0022
92.02.24.10	Adjustable tapered nozzle ϕ 10mm	145.0123



PART NO.	DESCRIPTION	ORIGINAL REF
92.05.24.M6	Tip Holder M6	142.0003



PART NO.	DESCRIPTION	ORIGINAL REF
92.05.24	Gas Diffuser - Ceramic	012.0017
92.05.24R	Gas Diffuser - Red Rubber	N/A



PART NO.	DESCRIPTION	ORIGINAL REF
92.06.24	Swan Neck	012.0001



PART NO.	DESCRIPTION	ORIGINAL REF
92.09.HANDLE	Ergonomic handle with screws	N/A
92.09.BWT	Trigger	N/A



PART NO.	DESCRIPTION	ORIGINAL REF
92.01.15.06	Contact tip 0.6mm x M6 x 6mm dia x 25mm long	140.0008
92.01.15.08	Contact tip 0.8mm x M6 x 6mm dia x 25mm long	140.0059
92.01.15.09	Contact tip 0.9mm x M6 x 6mm dia x 25mm long	140.0177
92.01.15.10	Contact tip 1.0mm x M6 x 6mm dia x 25mm long	140.0253
92.01.25.06	Contact tip 0.6mm x M6 x 8mm dia x 25mm long	140.0005
92.01.25.08	Contact tip 0.8mm x M6 x 8mm dia x 25mm long	140.0051
92.01.25.09	Contact tip 0.9mm x M6 x 8mm dia x 25mm long	140.0169
92.01.25.10	Contact tip 1.0mm x M6 x 8mm dia x 25mm long	140.0242
92.01.25.12	Contact tip 1.2mm x M6 x 8mm dia x 25mm long	140.0379
92.01.25.14	Contact tip 1.4mm x M6 x 8mm dia x 25mm long	140.0516
92.01.25.16	Contact tip 1.6mm x M6 x 8mm dia x 25mm long	140.0555
92.01.M6A09	Contact tip 0.9mm x M6 Al x 8mm dia x 28mm long	141.0004
92.01.M6A10	Contact tip 1.0mm x M6 Al x 8mm dia x 28mm long	141.0006
92.01.M6A12	Contact tip 1.2mm x M6 Al x 8mm dia x 28mm long	141.0072

Steel Liners

Teflon Liners for Aluminium

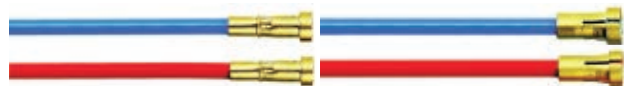

PART NO.	DESCRIPTION	ORIGINAL REF
92.04.B3	Blue steel liner 0.6 - 0.8mm 3mt	124.0011
92.04.B4	Blue steel liner 0.6 - 0.8mm 4mt	124.0012
92.04.B5	Blue steel liner 0.6 - 0.8mm 5mt	124.0015
92.04.R3	Red steel liner 0.9 - 1.2mm 3mt	124.0026
92.04.R4	Red steel liner 0.9 - 1.2mm 4mt	124.0031
92.04.R5	Red steel liner 0.9 - 1.2mm 5mt	124.0035
92.04.BT3	Blue teflon liner 0.6 - 0.9mm 3mt	126.0005
92.04.BT4	Blue teflon liner 0.6 - 0.9mm 4mt	126.0008
92.04.RT3	Red teflon liner 0.9 - 1.2mm 3mt	124.0011
92.04.RT4	Red teflon liner 0.9 - 1.2mm 4mt	124.0012
92.04.RT5	Red teflon liner 0.9 - 1.2mm 5mt	124.0015

BZ36 BOSSWELD BINZEL STYLE MIG TORCH SPARE PARTS

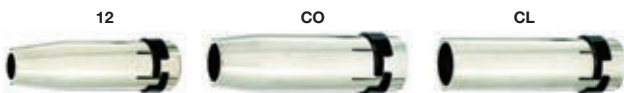

PART NO.	DESCRIPTION	ORIGINAL REF
92.02.36.12	Adjustable tapered nozzle \varnothing 12mm	145.0126
92.02.36.CO	Adjustable conical nozzle \varnothing 16mm	145.0078
92.02.36.CL	Adjustable cylindrical nozzle \varnothing 20mm	145.0045



PART NO.	DESCRIPTION	ORIGINAL REF
92.03.36.M6S	Tip holder M6 short 28mm	142.0005
92.03.36.M6L	Tip holder M6 long 32mm	142.0011
92.03.36.M8S	Tip holder M8 short 28mm	142.0020
92.03.36.M8L	Tip holder M8 long 32mm	142.0024



PART NO.	DESCRIPTION	ORIGINAL REF
92.05.36	Gas Diffuser	014.0261



PART NO.	DESCRIPTION	ORIGINAL REF
92.06.36	Swan neck	014.0006

Steel Liners



Teflon Liners for Aluminium



PART NO.	DESCRIPTION	ORIGINAL REF
92.04.B3	Blue steel liner 0.6 - 0.8mm 3mt	124.0011
92.04.B4	Blue steel liner 0.6 - 0.8mm 4mt	124.0012
92.04.B5	Blue steel liner 0.6 - 0.8mm 5mt	124.0015
92.04.R3	Red steel liner 0.9 - 1.2mm 3mt	124.0026
92.04.R4	Red steel liner 0.9 - 1.2mm 4mt	124.0031
92.04.R5	Red steel liner 0.9 - 1.2mm 5mt	124.0035
92.04.Y3	Yellow steel liner 1.2 - 1.6mm 3mt	124.0041
92.04.Y4	Yellow steel liner 1.2 - 1.6mm 4mt	124.0042
92.04.Y5	Yellow steel liner 1.2 - 1.6mm 5mt	124.0043
92.04.BT3	Blue teflon liner 0.6 - 0.9mm 3mt	126.0005
92.04.BT4	Blue teflon liner 0.6 - 0.9mm 4mt	126.0008
92.04.RT3	Red teflon liner 0.9 - 1.2mm 3mt	124.0011
92.04.RT4	Red teflon liner 0.9 - 1.2mm 4mt	124.0012
92.04.RT5	Red teflon liner 0.9 - 1.2mm 5mt	124.0015
92.04.YT3	Yellow teflon liner 1.2 - 1.6mm 3mt	126.0039
92.04.YT4	Yellow teflon liner 1.2 - 1.6mm 4mt	126.0042

M6 Standard Duty



M6 Heavy Duty



M8 Contact Tip



PART NO.	DESCRIPTION	ORIGINAL REF
92.01.25.06	Contact tip heavy duty 0.6mm x M6 x 8mm dia x 28mm long	140.0005
92.01.25.08	Contact tip heavy duty 0.8mm x M6 x 8mm dia x 28mm long	140.0051
92.01.25.09	Contact tip heavy duty 0.9mm x M6 x 8mm dia x 28mm long	140.0169
92.01.25.10	Contact tip heavy duty 1.0mm x M6 x 8mm dia x 28mm long	140.0242
92.01.25.12	Contact tip heavy duty 1.2mm x M6 x 8mm dia x 28mm long	140.0379
92.01.25.14	Contact tip heavy duty 1.4mm x M6 x 8mm dia x 28mm long	140.0516
92.01.25.16	Contact tip heavy duty 1.6mm x M6 x 8mm dia x 28mm long	140.0555
92.01.M6A09	Contact tip 0.9mm x M6 Al x 8mm dia x 28mm long	141.0004
92.01.M6A10	Contact tip 1.0mm x M6 Al x 8mm dia x 28mm long	141.0006
92.01.M6A12	Contact tip 1.2mm x M6 Al x 8mm dia x 28mm long	141.0072
92.01.M83008	Contact tip 0.8mm x M8 x 10mm dia x 30mm long	140.0014
92.01.M83009	Contact tip 0.9mm x M8 x 10mm dia x 30mm long	140.0214
92.01.M83010	Contact tip 1.0mm x M8 x 10mm dia x 30mm long	140.0313
92.01.M83012	Contact tip 1.2mm x M8 x 10mm dia x 30mm long	140.0442
92.01.M83014	Contact tip 1.4mm x M8 x 10mm dia x 30mm long	-
92.01.M83016	Contact tip 1.6mm x M8 x 10mm dia x 30mm long	140.0587



PART NO.	DESCRIPTION	ORIGINAL REF
92.04.BNL12	Brass swan neck liner 1.2mm (250mm)	120.0018
92.04.BNL16	Brass swan neck liner 1.6mm (250mm)	120.0041



PART NO.	DESCRIPTION	ORIGINAL REF
92.09.HANDLE	Ergonomic handle with screws	N/A
92.09.BWT	Trigger	N/A

BOSSWELD 26 SERIES 180AMP TIG TORCH COMPLETE & SPARES



PART NO.	DESCRIPTION
95.26F.4.1.SW9A	Bossweld 26 Series TIG Torch 4mt 9 pin Plug
95.26F.8.1.SW9A	Bossweld 26 Series TIG Torch 8mt 9 pin Plug



PART NO.	DESCRIPTION
9957Y04	Back Cap Short
9557Y05	Back Cap Medium
955Y02	Back Cap Long



PART NO.	DESCRIPTION
9518CG	Torch Body Front Insulator
9554N01	Torch Body Front Insulator Lens Cup



PART NO.	DESCRIPTION
9510N21	Collet 0.5mm
9510N22	Collet 1.0mm
9510N23	Collet 1.6mm
9510N24	Collet 2.4mm
9510N25	Collet 3.2mm
9510N20	Collet 4.0mm



PART NO.	DESCRIPTION
9510N29	Collet Body 0.5mm
9510N30	Collet Body 1.0mm
9510N31	Collet Body 1.6mm
9510N32	Collet Body 2.4mm
9510N28	Collet Body 3.2mm
95406488	Collet Body 4.0mm



PART NO.	DESCRIPTION
9510N50	Alumin Cup Size 4
9510N49	Alumin Cup Size 5
9510N48	Alumin Cup Size 6
9510N47	Alumin Cup Size 7
9510N46	Alumin Cup Size 8
9510N45	Alumin Cup Size 10
9510N44	Alumin Cup Size 12



PART NO.	DESCRIPTION
95WP26	Torch Head
954WP26V	Torch Head with Valve
95WP26F	Flex Torch Head
95WP26FV	Flex Torch Head with Valve



PART NO.	DESCRIPTION
9545V24	Gas Lens Collet 1.0mm
9545V25	Gas Lens Collet 1.6mm
9545V26	Gas Lens Collet 2.4mm
9545V27	Gas Lens Collet 3.2mm
9545V28	Gas Lens Collet 4.0mm



PART NO.	DESCRIPTION
9554N18	Gas Len Alumin Cup Size 4 - 6.0mm
9554N17	Gas Len Alumin Cup Size 5 - 8.0mm
9554N16	Gas Len Alumin Cup Size 6 - 9.5mm
9554N15	Gas Len Alumin Cup Size 7 - 11.0mm
9554N14	Gas Len Alumin Cup Size 8 - 12.7mm
9554N19	Gas Len Alumin Cup Size 11 - 17.5mm

BOSSWELD 3 METRE SPOOL GUN 240AMP - 9 PIN

This spool gun is the perfect solution for welding soft alloys, especially aluminium where feeding the aluminium MIG wire is always a challenge due to birds nesting, tangles and feedability problems. A spool gun overcomes these issues by providing a reliable solution that delivers the wire at the gun point with a short feed length compared to a standard mig gun length of at least 3 metres.



FEATURES

- Suits the X series range of machines.
- Primarily used for MIG (GMAW) welding of aluminium and aluminium alloys.
- Can be also used for MIG welding of mild steel and stainless steel.

TYPE	PART NO.
Spool Gun 4 metre 240 AMP	97.SPX24.4.9
Spool Gun 8 metre 240 AMP	97.SPX24.8.9

BOSSWELD 3 METRE SPOOL GUN 240AMP - 9 PIN



PART NO.	DESCRIPTION	ORIGINAL REF
92.02.24.CO	Adjustable conical nozzle ϕ 12.5 STD	145.0075
92.02.24.CL	Adjustable cylindrical ϕ 17mm	145.0022
92.02.24.10	Adjustable tapered nozzle ϕ 10mm	145.0123



PART NO.	DESCRIPTION	ORIGINAL REF
92.05.24.M6	Tip Holder M6	142.0003



PART NO.	DESCRIPTION	ORIGINAL REF
92.05.24	Gas Diffuser - Ceramic	012.0017
92.05.24R	Gas Diffuser - Red Rubber	N/A



PART NO.	DESCRIPTION	ORIGINAL REF
92.01.15.06	Contact tip 0.6mm x M6 x 6mm dia x 25mm long	140.0008
92.01.15.08	Contact tip 0.8mm x M6 x 6mm dia x 25mm long	140.0059
92.01.15.09	Contact tip 0.9mm x M6 x 6mm dia x 25mm long	140.0177
92.01.15.10	Contact tip 1.0mm x M6 x 6mm dia x 25mm long	140.0253
92.01.25.06	Contact tip 0.6mm x M6 x 8mm dia x 25mm long	140.0005
92.01.25.08	Contact tip 0.8mm x M6 x 8mm dia x 25mm long	140.0051
92.01.25.09	Contact tip 0.9mm x M6 x 8mm dia x 25mm long	140.0169
92.01.25.10	Contact tip 1.0mm x M6 x 8mm dia x 25mm long	140.0242
92.01.25.12	Contact tip 1.2mm x M6 x 8mm dia x 25mm long	140.0379
92.01.25.14	Contact tip 1.4mm x M6 x 8mm dia x 25mm long	140.0516
92.01.25.16	Contact tip 1.6mm x M6 x 8mm dia x 25mm long	140.0555
92.01.M6A09	Contact tip 0.9mm x M6 Al x 8mm dia x 28mm long	141.0004
92.01.M6A10	Contact tip 1.0mm x M6 Al x 8mm dia x 28mm long	141.0006
92.01.M6A12	Contact tip 1.2mm x M6 Al x 8mm dia x 28mm long	141.0072

HELPFUL INFORMATION

Filler Metal

Solid Mild Steel wire

Notes

- Use Industry standard - copper coated ER70S-6 Steel MIG Wire. This requires a shielding gas (CO2 or argon/CO2 mix), excellent results on panel steel.

Gasless Flux cored Mild Steel Wire
(Known as GS)

- Use Industry standard flux cored ER71T-GS Steel MIG Wire. This does not require a shielding gas.
- Suitable for outside use where gas shield can be blown away or not available.
- Suitable for seldom use or when bottle hire is not practical or too costly for small jobs and infrequent use.
- Great on galvanised materials
- Not suitable for panel steel
- Leaves chalky residue. This is normal.
- Produces smoke and splatters.

Drive Feed Roller Selection

It is important that correct drive roller is used to get the best results.

Solid mild steel
Stainless steel wire

“V” groove Roller. Roller has a small V shaped groove to guide the wire.

Flux cored wire

“V Knurled” roller (assists in gripping as wire is soft)

Aluminium wire

“U” groove Roller (assist in gripping as wire is softest)

Polarity

Machine can be used in both DC + and DC - modes

Wire Type -Gas shield wire
(solid or CO2 shielded flux)

“-” earth

Self-shielded
Flux core Wire

“+” earth

Aluminium

3m only for push torch, Teflon liner, “U” groove roller, alloy tips or one size larger, argon shielding wire

TROUBLE SHOOTING

Issue	Possible Reason	Suggested Remedy
Power indicator is not lit, fan does not work and no output current	<ul style="list-style-type: none"> • Welder is not plugged into power supply • Circuit breaker may have operated • Main power switch may not be in the ON position 	<ul style="list-style-type: none"> • Check that the welder is plugged into the 240V mains outlet and is switched on. • Check that the mains fuse or breaker has not operated. • Check that the main switch on the rear of the unit is in the on position.
Power indicator is lit, fan works, no output current	<ul style="list-style-type: none"> • Output connectors may be disconnected or damaged • Welding cables or earth clamp not connected properly 	<ul style="list-style-type: none"> • Check output connectors are connected properly and are not damaged • Check connections and that workpiece is free of paint and rust at connection point
Over temperature indicator is on, no output current	<ul style="list-style-type: none"> • Duty cycle of the unit has been exceeded. . 	<ul style="list-style-type: none"> • Allow the unit to cool for 20 minutes
Output current is not stable.	<ul style="list-style-type: none"> • Earth clamp connection loose • Mains Voltage is not constant • Loose welding cables • Leads reversed 	<ul style="list-style-type: none"> • Check earth clamp is connected to work piece properly. • Change the Main Supply to an alternative • Check the welding connectors are tight in the sockets. • Check Leads are not reversed and correct +/-
Hot Welding Clamp	Welding clamp rated current is too small,	Replace with larger size welding clamp.
Excessive Spatter	<ul style="list-style-type: none"> • Wire feed speed set too high • Voltage too high • Wrong polarity set • Stick out too long • Contaminated base metal Contaminated MIG wire • Inadequate gas flow or too much gas flow • Worn contact tip 	<ul style="list-style-type: none"> • Select lower wire feed speed • Select a lower voltage setting • Select the correct polarity for the wire being used • Bring the torch closer to the work • Remove materials like paint, grease, oil, and dirt, including mill scale from base metal • Use clean dry rust free wire. Do not lubricate the wire with oil, grease etc • Check the gas is connected, check hoses, gas valve and torch are not restricted. Set the gas flow between 6-12 l/min flow rate. Check hoses and fittings for holes, leaks. Protect the welding zone from wind and drafts • Change contact tip.
Porosity - small cavities or holes resulting from gas pockets in weld metal	<ul style="list-style-type: none"> • Wrong gas • Inadequate gas flow or too much gas flow • Moisture on the base metal • Contaminated base metal • Contaminated MIG wire • Loose gas connection 	<ul style="list-style-type: none"> • Check that the correct gas is being used • Check the gas is connected; check hoses, gas valve and torch are not restricted. Set the gas flow between 10 - 15 l/min flow rate. Check hoses and fittings for holes, leaks etc. Protect the welding zone from wind and drafts • Remove all moisture from base metal before welding • Remove materials like paint, grease, oil, and dirt, including mill scale from base metal • Use clean dry rust free wire. Do not lubricate the wire with oil, grease etc. Check and tighten connection.

TROUBLE SHOOTING - CONTINUED

Issue	Possible Reason	Suggested Remedy
Porosity - small cavities or holes resulting from gas pockets in weld metal	<ul style="list-style-type: none"> • Gas nozzle clogged with spatter, worn or out of shape • Missing or damaged gas diffuser • MIG torch euro connect O-Ring missing or damaged 	<ul style="list-style-type: none"> • Clean or replace the gas nozzle • Replace the gas diffuser • Check and replace the O-Ring
Wire stubbing during welding	<ul style="list-style-type: none"> • Holding the torch too far away • Welding voltage set too low • Wire speed set too high 	<ul style="list-style-type: none"> • Bring the torch closer to the work and maintain stick out of 5-10mm • Increase the voltage • Decrease the wire feed speed
Lack of Fusion – failure of weld metal to fuse completely with base metal or a proceeding weld bead	<ul style="list-style-type: none"> • Contaminated base metal • Not enough heat input • Improper welding technique • Too much heat 	<ul style="list-style-type: none"> • Remove materials like paint, grease, oil, and dirt, including mill scale from base metal • Select a higher voltage range and /or adjust the wire speed to suit <p>Keep the arc at the leading edge of the weld pool. Gun angle to work should be between 5 & 15° Direct the arc at the weld joint</p> <p>Adjust work angle or widen groove to access bottom during welding, Momentarily hold arc on side walls if using weaving technique</p> <ul style="list-style-type: none"> • Select a lower voltage range and /or adjust the wire speed to suit Increase travel speed
Excessive Penetration – weld metal melting through base meta	<p>Poor in incorrect joint preparation</p>	<ul style="list-style-type: none"> • Material too thick. Joint preparation and design needs to allow access to bottom of groove while maintaining proper welding wire extension and arc characteristics Keep the arc at the leading edge of the weld pool and maintain the gun angle at 5 & 15° keeping the stick out between 5-10mm
Lack of Penetration – shallow fusion between weld metal and base metal	<ul style="list-style-type: none"> • Not enough heat input • Contaminated base metal 	<ul style="list-style-type: none"> • Select a higher voltage range and /or adjust the wire speed to suit Reduce travel speed • Remove materials like paint, grease, oil, and dirt, including mill scale from base metal

MIG WIRE FEED TROUBLE SHOOTING

The following chart addresses some of the common WIRE FEED problems during MIG welding.

Issue	Possible Reason	Suggested Remedy
No wire feed	<ul style="list-style-type: none"> • Wrong mode selected 	<ul style="list-style-type: none"> • Check that the TIG/MMA/MIG selector switch set to MIG position
Inconsistent / interrupted wire feed	<ul style="list-style-type: none"> • Adjusting wrong dial • Wrong polarity selected • Incorrect wire speed setting • Voltage setting incorrect • MIG torch lead too long • MIG torch lead kinked or too sharp angle being held • Contact tip worn, wrong size, wrong type • Liner worn or clogged (the most common causes of bad feeding) • Wrong size liner • Blocked or worn inlet guide tube • Wire misaligned in drive roller groove • Incorrect drive roller size • Wrong type of drive roller selected • Worn drive rollers • Drive roller pressure too high • Too much tension on wire spool hub • Wire crossed over on the spool or tangled • Contaminated MIG wire 	<ul style="list-style-type: none"> • Be sure to adjust the wire feed and voltage dials for MIG welding. The amperage dial is for MMA and TIG welding mode. • Select the correct polarity for the wire being used - see machine set up. • Adjust the wire feed speed • Adjust the voltage setting Small diameter wires and soft wires like aluminium don't feed well through long torch leads - replace the torch with a lesser length torch. • Remove the kink, reduce the angle or bend • Replace the tip with correct size and type • Try to clear the liner by blowing out with compressed air as a temporary cure, it is recommended to replace the liner. • Install the correct size liner • Clear or replace the inlet guide tube • Locate the wire into the groove of the drive roller • Fit the correct size drive roller e.g. 0.8mm wire requires 0.8mm drive roller. • Fit the correct type roller (e.g. knurled rollers needed for flux cored wires). • Replace the drive rollers Can flatten the wire electrode causing it to lodge in the contact tip - reduce the drive roller pressure. • Reduce the spool hub brake tension • Remove the spool untangle the wire or replace the wire. • Use clean dry rust free wire. Do not lubricate the wire with oil, grease etc.

OPERATIONAL ENVIRONMENT

- Height above sea level $\leq 1000\text{m}$
- Operation temperature range $-10^{\circ}\text{C} \sim +40^{\circ}\text{C}$
- Air relative humidity is below 90% (20°C)
- Preferably sit the machine above floor level, ensure the maximum angle does not exceed 15 degrees.
- Protect the machine against heavy rain and against direct sunshine.
- The content of dust, acid, corrosive gas in the surrounding air or substance must not exceed normal standards.
- Take care that there is sufficient ventilation during welding.
There must be at least 30cm free distance between the machine and wall.



OTHER PRODUCTS IN OUR RANGE

- ELECTRODES
- TIG RODS
- WELDING HELMETS
- WELDING MACHINES
- TORCH SPARE PARTS
- WELDING ACCESSORIES
- MIG WIRE
- GAS EQUIPMENT
- WELDING SAFETY
- MIG TORCHES
- TIG TORCHES
- WELDING CABLE

BOSSWELD WELD LIKE A BOSS

X series